

# Audi S5 Sportback



## Index

<b>The Audi S5 Sportback</b>	Overview	1
<b>Performance and Engine</b>	Performance	2
	Engine	3
	Performance Features	4
<b>Equipment</b>	Exterior	5
	Exterior Features	6
	Interior	7
	Interior Features	8
	Technology and Infotainment	9
	Technology Features	10
	Standard Features	11
	Optional Features	12
<b>Colour and Styling</b>	Exterior Colour Options	13
	Interior Colour Options	14
<b>Others</b>	Technical Data	15

## Future is an attitude

The new Audi S5 Sportback defines performance and style in its most progressive form. Bringing together the powerful engine and refined suspensions, with the sleek, sharp design and innovative technological features, the Audi S5 is the flawless fusion of a sports car and a premium sedan.

Image for representation purpose only.



## Performance

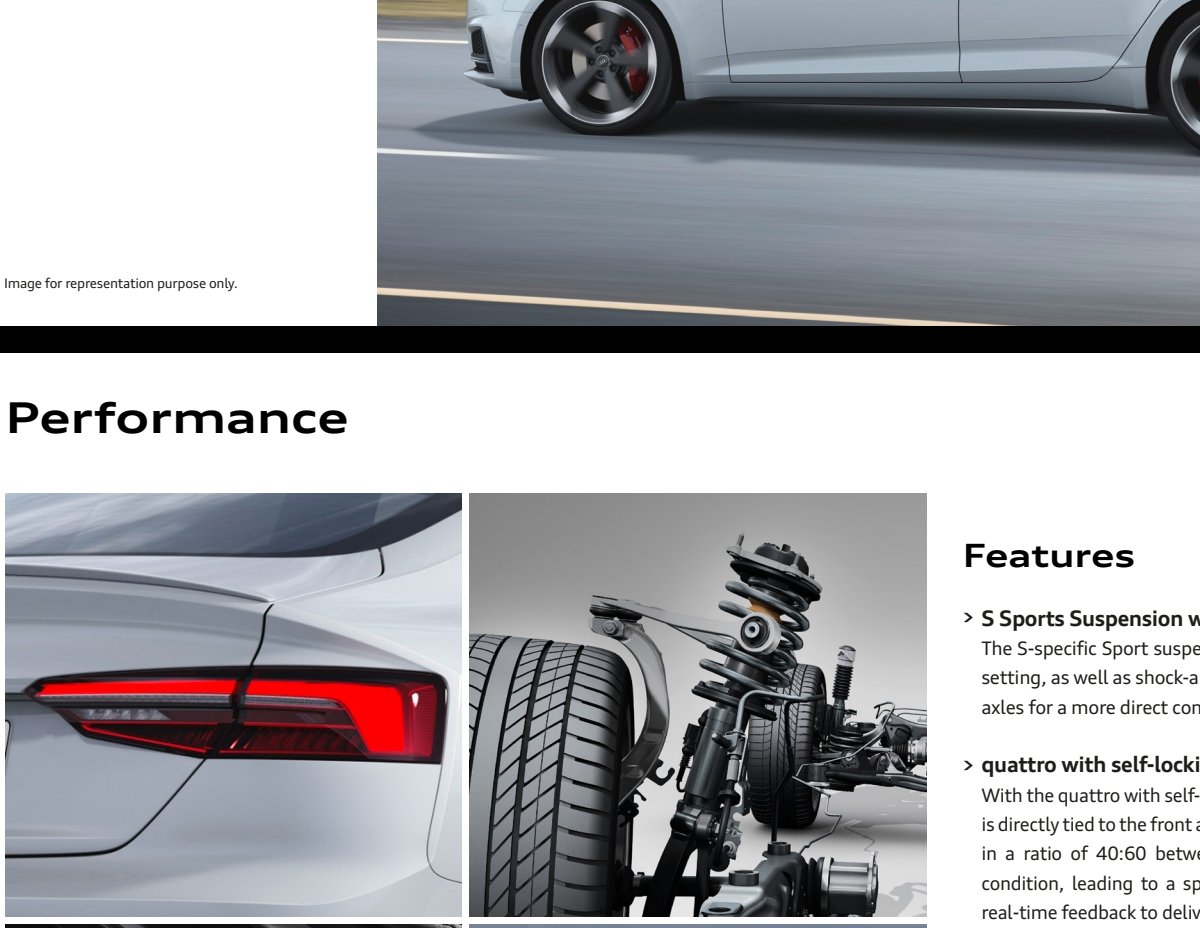

### Potential meets possibilities

The new Audi S5 handles like a dream for those who love speed. With a 3.0 L V6 TFSI Petrol engine, the S5 produces a torque of 500 Nm and a maximum power of 354 hp. It goes from 0-100 in just 4.8 seconds, and has a top speed of 250 kmph. It's top performance, at your disposal.

Image for representation purpose only.

## Performance

- Power**  
354 hp  
(260 kW)
- Torque**  
500 Nm
- Acceleration**  
4.8 sec  
(0-100 km/h)
- Top Speed**  
250 km/h

Image for representation purpose only.



## Performance

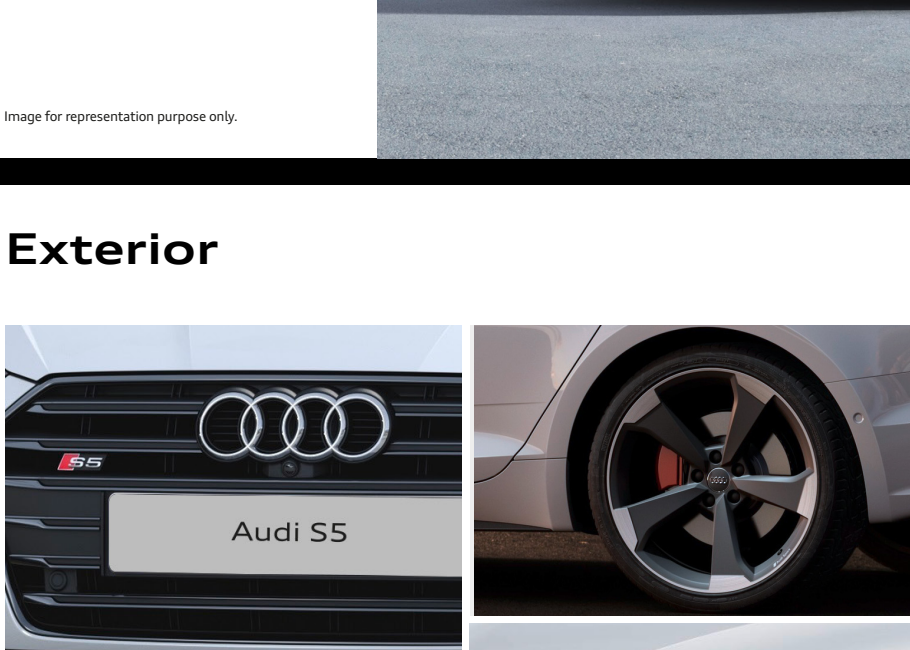

### Features

- > **S Sports Suspension with Damper control**  
The S-specific Sport suspension comes with a stiffer spring and damper setting, as well as shock absorbers and coil springs on the front and rear axles for a more direct contact with the road and sporty handling.
- > **quattro with self-locking differential**  
With the quattro with self-locking differential, the mechanical differential is directly tied to the front and rear axles, allowing torque to be distributed in a ratio of 40:60 between the front and rear axles in normal drive condition, leading to a sportier, rear-biased handling. It also gives you real-time feedback to deliver a more hands-on driving experience.
- > **Start-Stop Switching**  
The Start-Stop function helps reduce fuel consumption and CO2 emissions by switching the engine off when the vehicle is stationary and starts back as soon as the driver releases the brake.
- > **Audi Drive Select**  
The Audi Drive Select comes as a standard with the Audi S5, and has a total of 4 driving modes to choose from - auto, comfort, dynamic and individual.

Image for representation purpose only.

## Exterior

### Effortless grace

The Audi S5 combines a progressive design with a sporty look. It looks graceful in motion and equally so when parked. The standard S-specific elements on the exterior of the Audi S5 Sportback underscore its sporty design: S bumpers, radiator grille with honeycomb design in matt titanium black with inserts in matt aluminium silver, wide air inlets in the front and black aluminium silver at the front. The sporty chrome trims around the windows and a large rear spoiler accentuate the car's aesthetic exterior even further.

Image for representation purpose only.

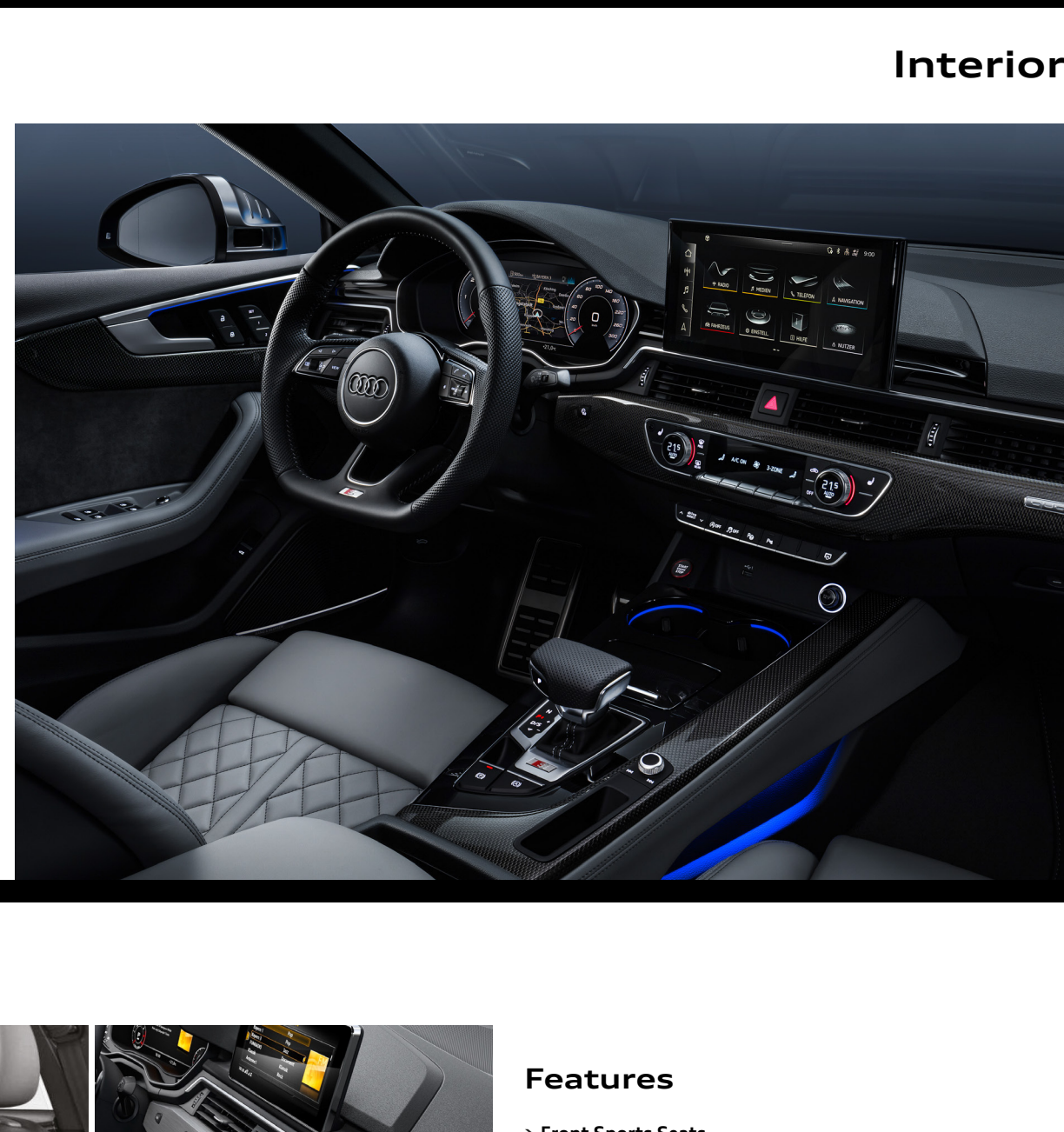

## Exterior



### Features

- > **Black Styling Package\***  
Black is always in style. Get the black styling package for your Audi S5, to make it stand out even more.
- > **High-Gloss styling package**  
Catch some eyes and turn some heads with the Audi S5's high-gloss styling package. Add a glossy highlight to your car's bumpers with aluminium trim exterior mirror housing and more.
- > **Panoramic Sunroof**  
Our large, glass panoramic sunroof provides front row seats to the glorious view of the sky from inside the car.
- > **Audi Matrix LED Headlamps**  
The Audi Matrix LED Headlamps bring together LED light sources with precision optics for highly adapted light distribution. Dipped beam, high beam, daytime running lights, and a host of other such features light the path ahead for your Audi S5.
- > **48.26cm (R19), 5-arm cutter, Anthracite black, high gloss**  
New 48.26 cm (R19) Wheels Travel along new roads in style with the 5-arm cutter high gloss in Anthracite black.

All features marked (\*) are optional. Image for representation purpose only.

## Interior

### Invitingly Innovative

The interior of the Audi S5 Sportback is impressively sporty. Thanks to the standard inlays in matt brushed aluminium and black leather-bottomed leather steering with multifunction plus with S emblem. The horizontal design elements, high-quality materials and state-of-the-art infotainment platform create a special sense of space.

Image for representation purpose only.

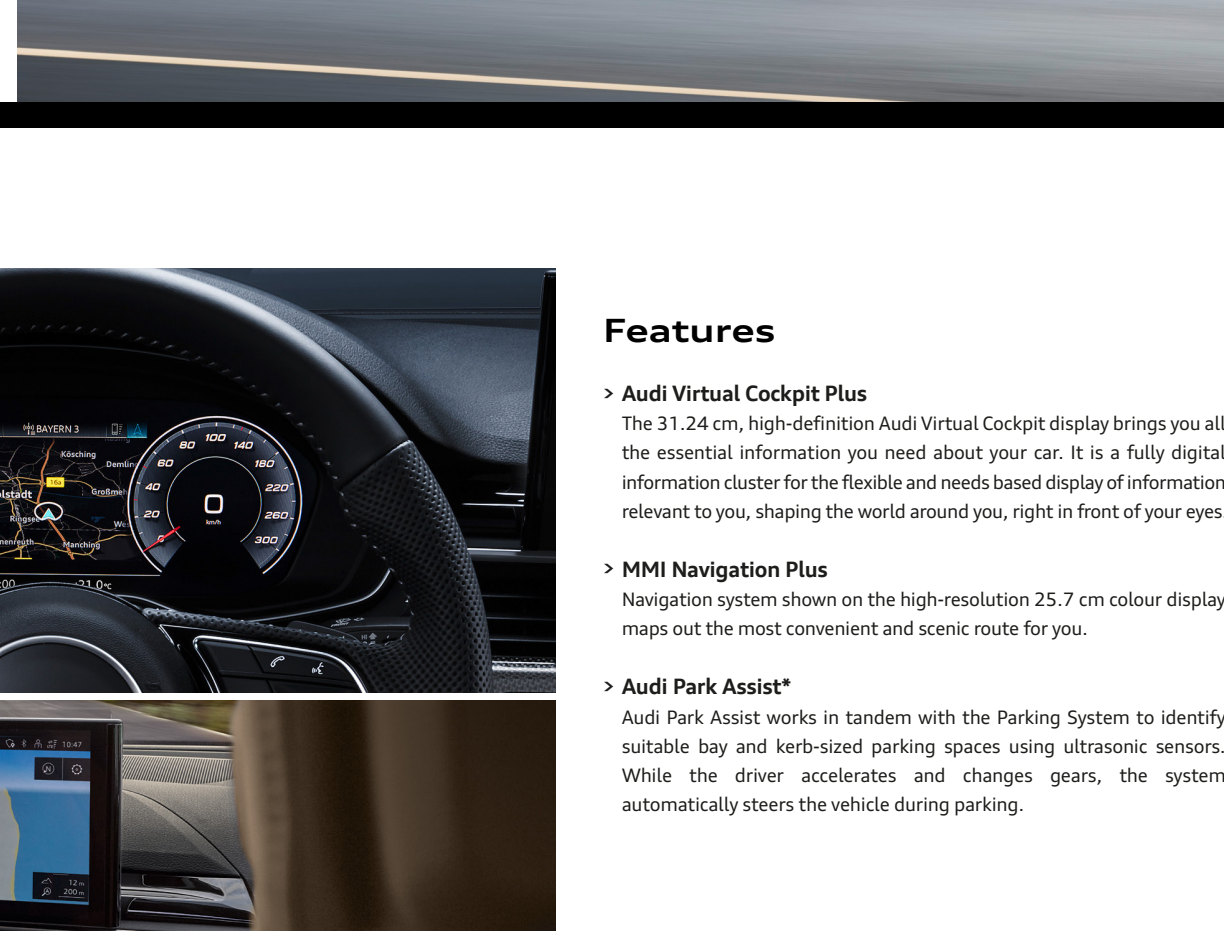

## Interior



### Features

- > **Front Sports Seats**  
The Audi S5's front sports seats are stylish and extremely comfortable, coming in soft, premium Alcantara/Leather upholstery. The seats are electronically adjustable, while also being smart enough to memorise the driver's adjustment preferences.
- > **3 Zone Automatic Air Conditioning**  
Get the temperature of your Audi S5 according to your preferences with the 3 Zone Automatic Air Conditioning, with air temperature controls in the front for the driver, centre console, and in the rear, too.
- > **Bang & Olufsen Premium Sound System\***  
A state-of-the-art sound system, the Bang & Olufsen Premium Sound System is a class apart. With 19 loudspeakers all over the car and the ones in front illuminating, a 755 W, 16-channel amplifier, and a unique three-dimensional sound reproduction thanks to the Synphonia technology, you can now rock in the Audi S5 to your own beat.
- > **Contour Ambient Lighting**  
With the Contour Lighting Package, the Audi S5 greets you with a soft ambient glow as soon as you enter it. Sprucing up the centre console, the glove compartment and even the footwell and the underside of the door.

All features marked (\*) are optional. Image for representation purpose only.

## Technology

### Street Smart

With the Audi S5's smart, intuitive features the driver always feels a sense of command. Every detail is designed to make the driver feel one with the machine and the world around. The 25.7 cm MMI Navigation plus with MMI touch and the Audi Virtual Cockpit plus, offers essential information and intuitive control help you stay ahead of the curve, always.

Image for representation purpose only.

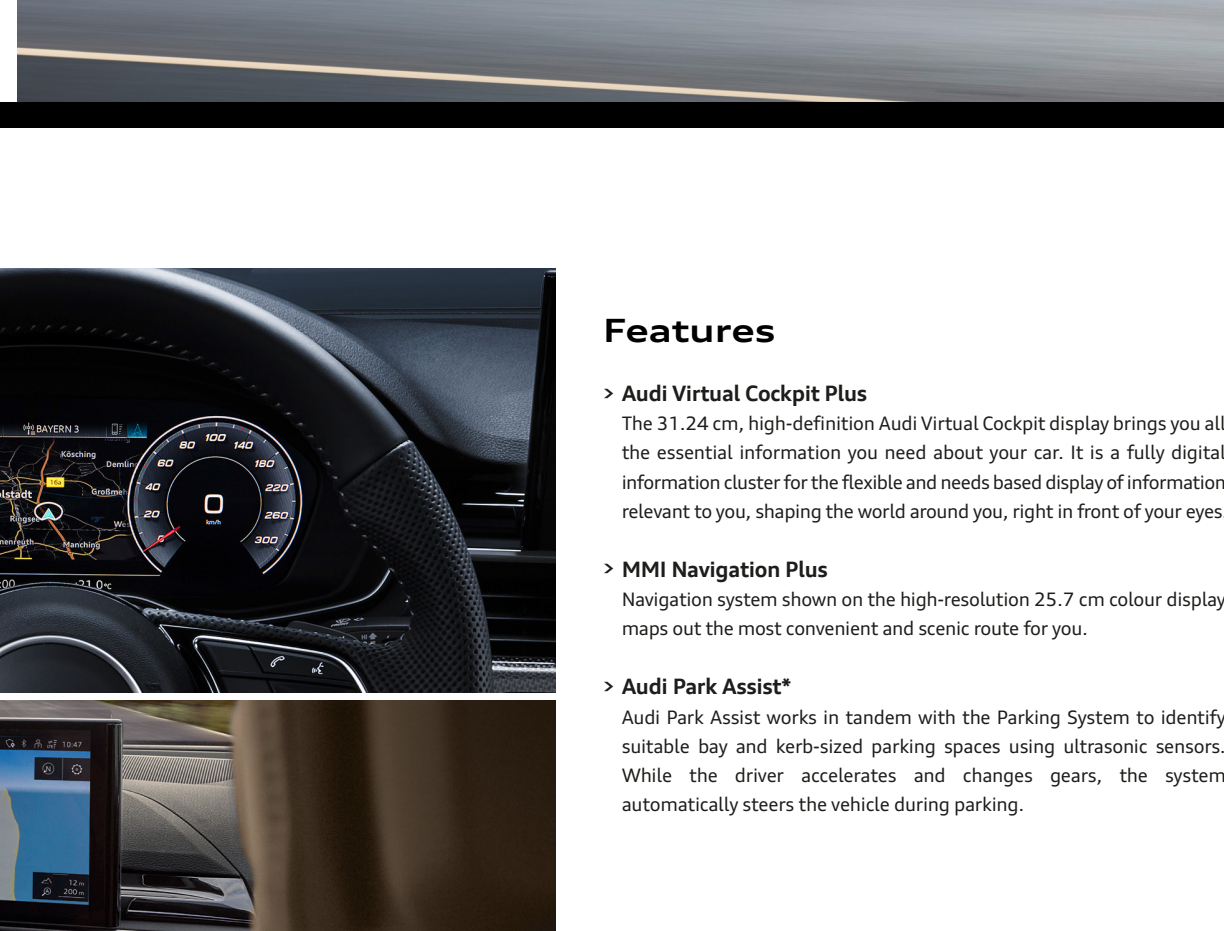

## Technology



### Features

- > **Audi Virtual Cockpit Plus**  
The 31.24 cm, high-definition Audi Virtual Cockpit display brings you all the essential information you need about your car. It is a fully digital information cluster for the flexible and needs based display of information relevant to you, shaping the world around you, right in front of your eyes.
- > **MMI Navigation Plus**  
Navigation system shown on the high-resolution 25.7 cm colour display maps out the most convenient and scenic route for you.
- > **Audi Park Assist\***  
Audi Park Assist works in tandem with the Parking System to identify suitable bay and kerb-sized parking spaces using ultrasonic sensors. While the driver accelerates and changes gears, the system automatically steers the vehicle during parking.

All features marked (\*) are optional. Image for representation purpose only.



### Standard Features

- > Audi Virtual Cockpit plus
- > Panoramic Glass Sunroof
- > Audi Phone Box Light
- > Matrix LED Headlamps with dynamic turn signal
- > MMI Navigation Plus with MMI touch
- > LED Rear Headlights with dynamic flashing light
- > Sports Contour Flat-Bottomed Steering Wheel
- > Audi Drive Select
- > Parking aid plus with rear view camera
- > 3-Zone Climate Control
- > S Sports Suspension

Image for representation purpose only.

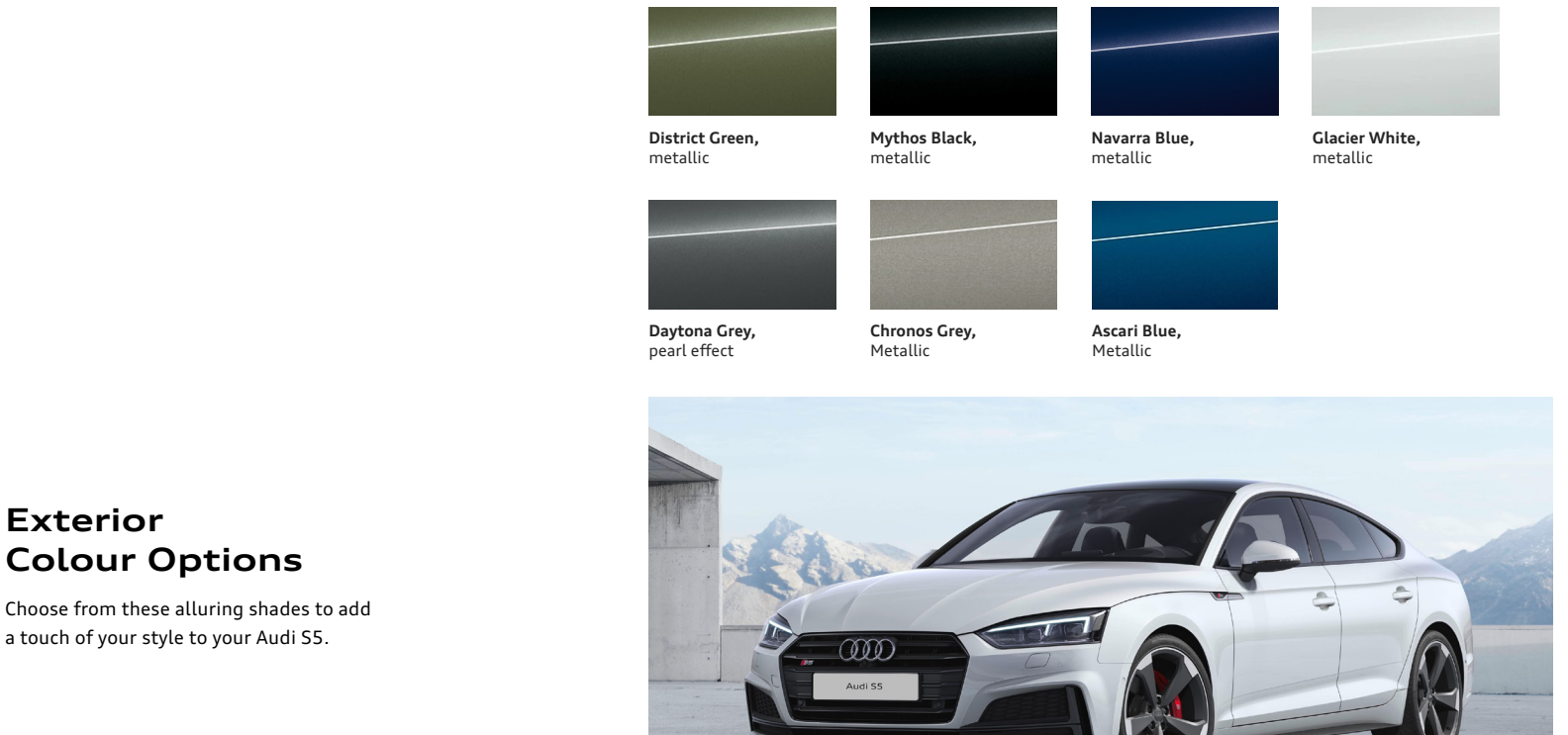

### Optional Features

- > Comfort key with sensor controlled complement release
- > Inlays in Piano Black Audi Exclusive
- > Inlays in Carbon Twill
- > Inlays in Carbon Twill
- > Brake calipers in Red
- > Audi exclusive Black Styling Package
- > Bang & Olufsen Premium Sound System
- > Audi Park Assist
- > Extended Leather Package Artificial Leather

Image for representation purpose only.



### Exterior Colour Options

Choose from the » alluring shades to add a touch of your style to your Audi S5.

Image for representation purpose only.

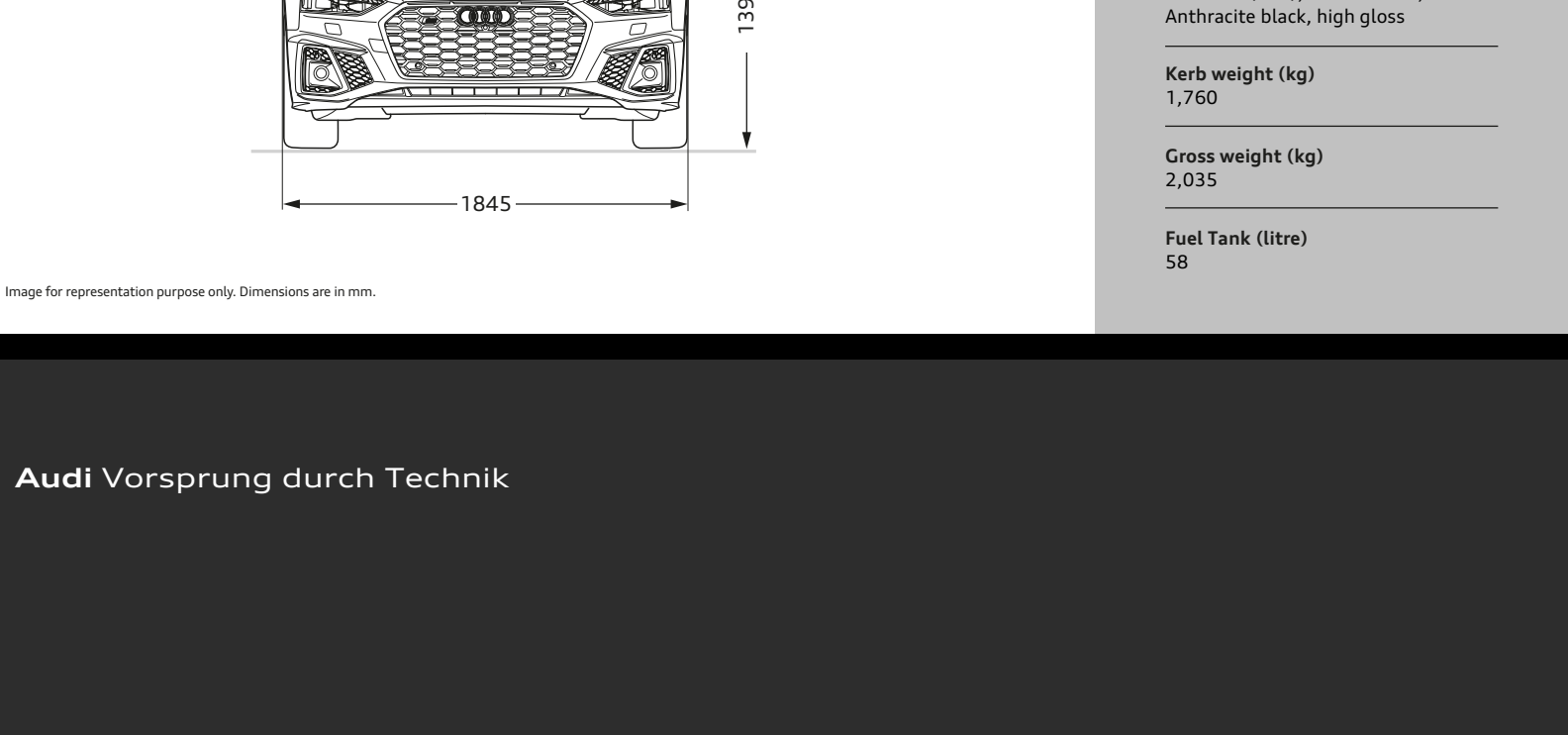
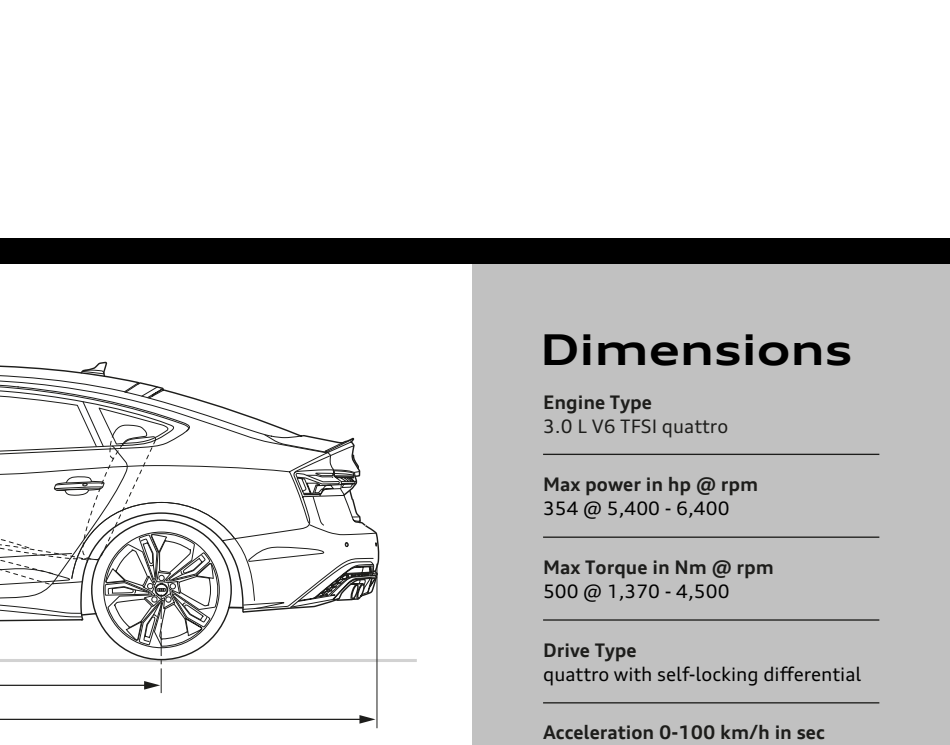

### Interior Colour Options

Making the interiors of your Audi S5 even more inviting with these interior options.

Image for representation purpose only.

## Audi Vorsprung durch Technik

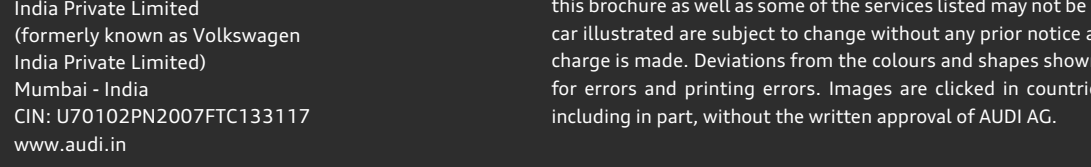

### Dimensions

Engine Type	3.0 L V6 TFSI quattro
Max power in hp @ rpm	354 @ 5,400 - 6,400
Max Torque in Nm @ rpm	500 @ 1,370 - 4,500
Drive Type	quattro with self-locking differential
Acceleration 0-100 km/h in sec	4.8 sec
Transmission	8-speed tiptronic
Wheel Type/Size	48.26cm (R19), 5-arm cutter, Anthracite black, high gloss
Kerb weight (kg)	1,760
Gross weight (kg)	2,035
Fuel Tank (litre)	58