

MULTISTRADA V2



Index

Multistrada V2

5	Your everyday wonder	33	Technical data and equipment
6	All-round Multistrada	44	Apparel
9	Engine Fully controlled power and torque	50	Accessories Configure the Ducati of your dreams
12	Design Unmistakeable Multistrada design	52	Ducati Digital Experience
16	Live the extraordinary		
20	Chassis Agile and intuitive		
22	Ergonomics Comfort, versatility and fun		
24	Electronics Flawless electronics and control		
28	Trim Travel		
30	Servicing and maintenance		





Your everyday wonder

The new Multistrada V2 is the ideal bike with which to enjoy any trip, versatile during everyday use and in the city but with the sportiness and unmistakable style that characterise every Ducati.

The latest twin to join the Ducati family is a real all-rounder, increasingly intuitive, comfortable, fun, and accessible, thanks to its reduced weight and the introduction of a 35 kW version for A2 licence holders.

The ergonomics have been developed to ensure greater accessibility in terms of both seat height (from 830 mm to 790 mm) and inner leg curve, while the 19" front wheel guarantees the utmost versatility.

The Multistrada V2 is a technologically advanced bike, with a sophisticated chassis and a comprehensive electronics package, without forgetting the engine, the latest evolution of the Testastretta 11°. Its accessibility and real versatility make the new Multistrada V2 the ideal gateway to the Ducati touring universe.

All-round Multistrada

Multistrada V2 is the ideal bike for an enjoyable, easy ride on any route and is designed to offer maximum comfort during long trips, as well as agility and effortlessness during everyday use. This, together with that unmistakable Ducati spirit, for pure pleasure through the twists and turns.

The 937 cc Testastretta 11° twin with desmodromic timing plays a fundamental role in defining the nature of this tourer, delivering a maximum power of 113 HP at 9000 rpm and maximum torque of 94 Nm at 6750 rpm (Euro 5 version). The set-up makes for outstanding delivery that is nevertheless manageable and ensures an excellent level of reliability as well as reduced maintenance costs.

With respect to the previous generation of mid-size Ducati dual, the highly regarded Multistrada 950,

the ergonomics have been revised so that the new Multistrada V2 is even more accessible. Reconfigured to better accommodate riders of all sizes, it features a new narrower and lower seat and new footpegs, inherited from the Multistrada V4, which are 10 mm further from the seat surface. The rear-view mirrors are also carried over from the Multistrada V4, while the hand guards separated by the brake and clutch reservoirs are brand-new and ensure greater robustness.

Certain components are optimised to make the new Multistrada V2 5 kg lighter. With a dry weight of just 199 kg, the bike has never been so intuitive and easy to handle. Electronics are top-of-line and include ABS Cornering, Ducati Traction Control, Vehicle Hold Control, the Ducati Brake Light and the four Riding Modes.



ENGINE

Fully controlled power and torque

The 937 cc Testastretta 11° engine is lighter and updated in terms of the gearing and clutch to ensure even smoother and more precise operation, with maximum power of 113 HP at 9000 rpm and maximum torque of 94 Nm at 6750 rpm (Euro 5 version). One strength of this engine is its ability to reconcile theoretically opposing traits. So, while it boasts an excellent level of reliability, it also ensures the same performance and character that distinguish every Ducati engine. All while offering smooth, easy to manage delivery. The rider enjoys a prompt response and all the power they need, whatever the riding conditions.

The new gearbox also makes for improved drive dogs and better shifting sensation, while facilitating the engagement of neutral. Updated electronic management guarantees a more precise Ducati Quick Shift (DQS), which comes as standard on the S version, the operating strategy now optimised when shifting both up and down.





The new clutch is more lightweight with its eight discs, while the gear selector drum now rotates on bearings, which means less friction and greater overall efficiency. And that's not all, as the clutch lever spring is now more loaded. This means the system is more precise, in that it can't get stuck in intermediate positions.

The updates made to the gearing and clutch, as well as the introduction of new rods and covers, make for an approximate 1.6 kg reduction in overall engine weight.

Reliable and robust, the engine boasts extended maintenance intervals, with an oil change required every 15,000 km and a valve clearance check every 30,000 km. The Multistrada world has never been so accessible. And this is underlined with the arrival of the brand-new 35 kW version for A2 licence holders who, for the first time, can enjoy the experience of riding a Ducati dual.

DESIGN

Unmistakeable Multistrada design

While fully respecting typical Ducati Multistrada style and identification codes, the design of the Multistrada V2 centres around two key elements, namely elegance and sportiness. The cornerstones of Ducati style are clean surfaces, flowing lines and a difference in volume, bigger at the front compared to the rear.

The Multistrada V2 inherits the rear-view mirrors and alloy wheels from its 'big sister', the Multistrada V4. And, as ever at Ducati, form follows function. As well as improving the aesthetic, these upgrades also constitute an overall weight saving. The hand guards and brake/clutch reservoirs have been separated, thereby adding to the stability and safety of the bike, even in the case of a fall. Additional design features include new engine covers and a new tail, redesigned to improve both ergonomics and comfort.

The Multistrada V2 also features a new livery with graphics that bear the name of the bike on both side panels. The colour range includes traditional "Ducati Red" with black wheels, available for both the Multistrada V2 and the Multistrada V2 S, and the new "Street Grey" livery with "GP Red" wheels, available to order for the S version only.





Live the extraordinary

Multistrada V2: versatility, performance and a blend of pleasure and riding ease make it the ideal companion with which to experience the beauty of travel, even the most unexpected, every single day. The 48 mm fork offers 170 mm of travel and is fully adjustable. In terms of rear suspension, a progressive spring boosts the level of riding comfort even at full load. Rear wheel travel is 170 mm.

On the S version, the Multistrada V2 is also equipped as standard with the Ducati Skyhook Suspension EVO (DSS) system, which is based on a 48 mm fork and a rear shock absorber, both electronic. The Skyhook system regulates compression and rebound damping thanks to a semi-active control that can guarantee the ideal bike balance and significantly boost both safety and comfort. Shock preload is also adjusted electronically.

To stave off tiredness when travelling long distances, the rider needs to be able to count on effective aerodynamic protection, ensured by the height adjustable plexiglas and carefully designed riding position. This is why the seat of the Multistrada V2 has been redeveloped, now lower and narrower between the rider's legs, while the footpegs ensure a less angled leg position, even for taller riders. Two trim packages can be installed directly at the factory, namely the Essential, available for both the Multistrada V2 and Multistrada V2 S, and the Travel trim with side panniers, heated hand grips and centre stand, which can only be ordered for the S version.





The experience Ducati Corse has gained in the aerodynamics field while competing in the prestigious MotoGP and Superbike World Championships is exploited to improve the production bikes. With the Multistrada V2, a model designed to effectively adapt to all types of use, protecting the rider and passenger from the air is clearly the most important aspect in terms of aerodynamics, especially during long journeys on the highway.

This is why the plexiglas is height adjustable for example, so that even the tallest riders can enjoy excellent protection against the wind. But before reaching the plexiglas, the air meets the front beak, designed specifically to reduce air pressure on the rider. The 'shoulders' of the tank are developed with the same goal, while also cohering with Multistrada family feeling.

In addition, the typical shape of the Multistrada, with greater volume at the front compared to the rear, allows

the air to "glide" around the rider and passenger.

Great attention is paid to thermal comfort and the direction of air flow from the radiators, a crucial aspect particularly in summer. Careful definition of the fairing profiles, the result of extensive research in the wind tunnel, ensures that hot air is deviated away from the rider and passenger, for maximum comfort on even the hottest days.



CHASSIS

Agile and intuitive

The chassis of the Multistrada V2 comprises a front trellis frame with large diameter tubes of reduced thickness, combined with two fused side sub-frames, closed with a rear supporting element in technopolymer.

The new, more lightweight aluminium alloy wheels are the same as those on the Multistrada V4 and measure 3.0" x 19" at the front and 4.5" x 17" at the rear. They mount Pirelli Scorpion Trail II tyres, in the 120/70 ZR19 size at the front and 170/60 ZR17 at the rear.

The entire Multistrada V2 family is equipped with Brembo brakes and an ABS system with Cornering function. The front braking system counts on Brembo radially mounted, 4-piston, monobloc callipers, a radial master cylinder with adjustable levers and two 320 mm discs. At the rear, a Brembo floating calliper acts on a single 265 mm disc.

The braking system also has a front-to-rear arrangement, meaning that use of the front brake lever also activates the correct proportion of rear brake.



ERGONOMICS

Comfort, versatility and fun



The new riding position is the linchpin of the Multistrada V2. Riding comfort, the sensation of having everything under control, air protection, and a safe contact point with the ground are the focal points of the new ergonomics, which once again centre attention on the rider. The aim? To make any type of travel easier and safer, whether touring, commuting or urban riding.

Essentially, the seat is now flatter, the new shape designed to allow the rider to move easily along the longitudinal axis. And that's not all, as a narrower seat

between the legs also means being able to reach the ground more easily when the bike is stationary, and safer handling of the bike at low speed, even at full load.

On request, the seat can be lowered further still, the low seat accessory combined with the lowered suspension kit (availability mid 2022, only for the S version). In this case, the distance between the seat and the asphalt is reduced to 790 mm. As a result, the Multistrada V2 can truly adapt to riders (and passengers) of all sizes.

And when it comes to travel, the space on board is that of a real tourer. The new Multistrada V2 can comfortably accommodate two people as well as a top case and side panniers, allowing them to experience the thrill of travel every single day, whether on tried and tested roads or off the beaten track, in line with the "Extraordinary Journey" philosophy.



ELECTRONICS

Flawless electronics and control

The safety, comfort, and performance of the Multistrada V2 are also guaranteed with state-of-the-art electronic support systems. On the S version, travel becomes a five-star experience thanks to a standout full optional package.

In 2010, the Multistrada became the first ever bike to be equipped with Riding Modes, which allow the rider to choose between pre-set modes to optimise vehicle behaviour based on their riding style and the environmental conditions. Eleven years later and the Multistrada V2 rider benefits from four Riding Modes (Sport, Touring, Urban and Enduro), which modify the bike's character depending on the rider's choices and the level of road grip.



The presence of the Bosch six-axis IMU (Inertial Measurement Unit) inertial platform allows for operation of the cornering systems, like ABS Cornering that varies its level of intervention depending on the bike's lean angle. For maximum safety, the rear features a LED light with Ducati Brake Light. In case of any violent braking, the rear light automatically begins to flash, signalling the sudden deceleration to any vehicles following behind. The front headlamp is full LED and comes complete with the Ducati Cornering Lights (DCL) function which optimises illumination of the road surface through the turn, based on the bike's lean angle. Automatic turn signal deactivation based on the lean angle and time elapsed is also available. Ducati Traction Control (DTC) can be adjusted according to eight levels on the Multistrada V2, while ABS Cornering can be set according to three intervention thresholds.



The Vehicle Hold Control (VHC) system helps the rider during a hill start. This function is activated when the user applies significant pressure to the front or rear brake while the bike is stationary, and the centre stand raised. At this point, the electronic system holds the Multistrada V2 still, intervening on the rear brake. Stay comfortable but stay connected.

This goes without saying aboard the new Multistrada V2. The Multistrada dashboard comprises a large, high-visibility LCD screen. Equipment on the S version is even more high-end, the model equipped with a high-res 5" colour TFT display with an intuitive interface that facilitates menu navigation.

Both versions are suitable for use with the Ducati Multimedia System,

which allows for the connection of a smartphone and the management music and calls, as well as enabling a Bluetooth connection with helmet intercoms.



TRAVEL EQUIPMENT

Customise your Multistrada directly at the factory

Two trims for the Multistrada V2 family can be ordered directly from the factory. The Essential trim is available for both the Multistrada V2 and Multistrada V2 S, while the Travel trim with side panniers, heated hand grips and centre stand as standard can only be ordered for the S version.



Servicing and maintenance

Safety as standard

The continuous work that Ducati carries out in terms of design, research and development has the specific aim of ensuring bikes are always cutting-edge and offer the ultimate level of active safety. A commitment that means defining increasingly advanced systems that heighten the level of rider control during the most delicate riding phases.

The Multistrada V2 can be fully customised in terms of its suspension, performance, comfort and safety and comes complete with the most advanced rider support systems, or rather Riding Modes, Power Mode, Ducati Safety Pack (ABS Cornering , Ducati Traction Control), Ducati Brake Light, Vehicle Hold Control, Ducati Cornering Light.

Choose your Multistrada and start your adventure!

Ducati offers you a four-year warranty on all models in the MY 2021 Multistrada family. Born to satisfy a thirst for travel - no borders, no compromise - the Multistrada offers the utmost in technology, performance, and design. Characteristics that are combined with rider and passenger comfort to achieve just one goal, namely to cover ever-increasing distances. A warranty made possible thanks to the experience of Ducati and its dealer network. A competent and continuously updated team treats every Ducati bike with the same care provided during its design and assembly in Borgo Panigale, so that all you need think about when riding your Multistrada is the next destination.

To find out whether 4Ever Multistrada is available in your country and to receive more information, contact your Ducati dealer or visit [ducati.com](https://www.ducati.com).

Endless excitement

In designing each bike, Ducati always sets itself the goal of ensuring maximum reliability while reducing maintenance costs. A commitment that has seen it extend the main service interval to 30,000 km (18,000 miles), during which a valve clearance check and registration is carried out as required. Even the simplest operations, like the Oil Service, are now scheduled at 15,000 km (9,000 miles) or 24 months.

An interval that is unbeatable in the two-wheeled world and that only confirms the very high quality standards Ducati applies to its material selection and R&D processes. Ducati continuously invests in the technical training of its dealers. The specific knowledge of official Ducati Service network members means that all operations needed to keep every Ducati in perfect working order are meticulously carried out. Advanced equipment such as the Ducati Diagnosis System ensures every Ducati will always have the latest software updates so that the electronic systems continue to perform at the highest level.

Always by your side

One of Ducati's main goals is to offer every Ducatista the chance to enjoy unlimited and safe travel all over the world. To achieve this aim, Ducati offers a "fast delivery" original spares service, with delivery in 24/48 hours across 85% of the areas in which it operates. With a distribution network that covers more than 91 countries, thanks to 738 official Dealers and Service Points*, choosing a Ducati means you can travel worry free and in total freedom, wherever the road may take you, and count on support from our extensive Dealer network that ensures Ducati quality and professionalism is always close at hand.

738 Authorised dealers and service points

91 World countries

*Information updated as of February 2021



4|Ever
Multistrada*

* Only for countries where 4ever Multistrada warranty applies



*Equal to 18,000 miles.



Technical data and equipment



MULTISTRADA V2

Dimensions

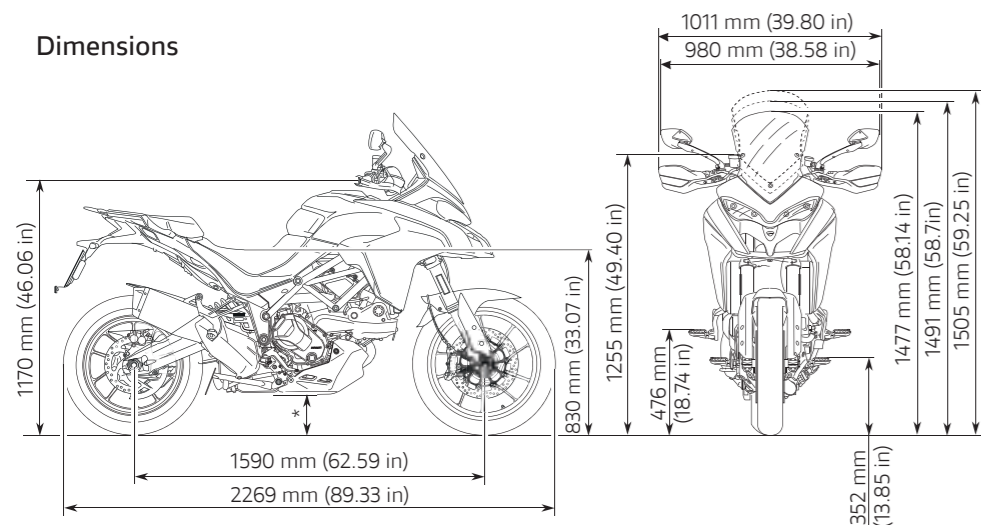

*177 mm (with technopolymer sump guard) 166 mm (with aluminium sump guard)

Power and torque

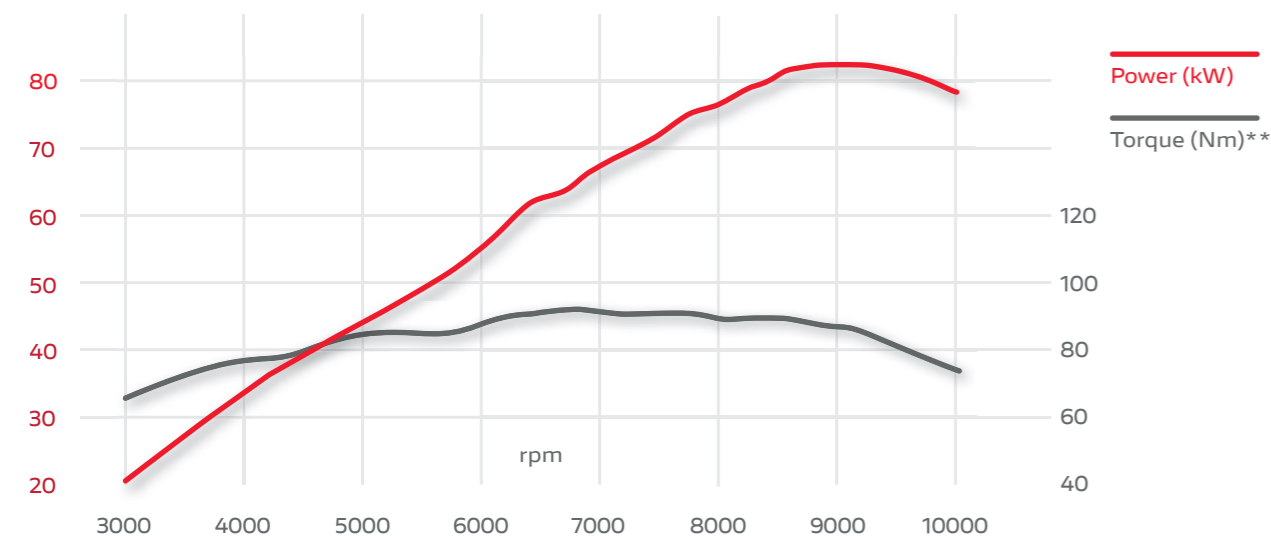

Engine

Engine Ducati Testastretta, L-Twin cylinder, Desmodromic valvetrain, 4 valves per cylinder, Liquid cooled

Displacement 937 cc (57.2 cu in)

Bore X Stroke 94 x 67.5 mm

Compression ratio 12.6:1

Power 113 hp (83 kW) @ 9,000 rpm

Torque 96 Nm (9.8 kgm, 71 lb ft) @ 7,750 rpm
94 Nm (9.6 kgm, 69 lb ft) @ 6,750 rpm*

Fuel injection Electronic fuel injection system, Ø 53 mm throttle bodies with Ride-by-Wire system

Exhaust Stainless steel single muffler, Catalytic converter and 2 lambda probes

Transmission

Gearbox 6 speed

Primary drive Straight cut gears; Ratio 1.84:1

Ratio 1=37/15, 2=30/17, 3=28/20, 4=26/22, 5=24/23, 6=23/24

Final drive Chain; Front sprocket 15; Rear sprocket 43

Clutch Slipper and self-servo wet multiplate clutch with hydraulic control

Chassis

Frame Tubular steel trellis frame

Front suspension Ø 48 mm fully adjustable usd fork

Front wheel Light alloy casted 3.0" x 19"

Front tyre Pirelli Scorpion Trail II 120/70 ZR 19

Rear Suspension Fully adjustable monoshock, Remote spring preload adjustment, Aluminium double-sided swingarm

Rear wheel Light alloy casted 4.5" x 17"

Rear tyre Pirelli Scorpion Trail II 170/60 ZR 17

Wheel travel (front/rear) 170 mm / 170 mm (6.7 in / 6.7 in)

Front brake 2 x Ø 320 mm aluminum flange semi-floating discs, Radially mounted Brembo monobloc 4-piston 2-pad callipers, Radial Master Cylinder, Cornering ABS

Rear brake Ø 265 mm disc, 2-piston Brembo floating calliper, Cornering ABS

Instrumentation LCD Display

Dimensions and Weights

Dry weight 199 kg (439 lb)

Kerb weight* 222 kg (489 lb)

Seat height 830 mm (32.7 in)

Wheelbase 1,594 mm (62.8 in)

Rake 25°

Trail 106 mm (4.2 in)

Fuel tank capacity 20 l (5.3 US Gal)

Number of seats Dual seat

Safety equipment

Riding Modes, Power Modes, Ducati Safety Pack (Cornering ABS, Ducati Traction Control), Ducati Brake Light, Vehicle Hold Control

Standard equipment

Self cancelling turn indicators

Ready for

Ducati Quick Shift up/down, Ducati Multimedia System, Antitheft system

Warranty and Maintenance

Warranty 24/48** months, Unlimited mileage

Maintenance 15,000 km (9,000 miles) / 24 months

Valve clearance check 30,000 km (18,000 miles)

Emissions and Consumption*

Standard Euro 5

CO₂ emissions 137 g/km

Consumption 5,9 l/100km



Equal to 18,000 miles.

Indication of mileage at the first Desmo Service, or rather the first service during which valve clearance is checked and adjusted if necessary.

The Multistrada V2 is also available for holders of limited driving license in a version with reduced power to 35 kW. Contact your dealer to check availability.

* Only for countries where Euro 5 standard applies

** Only for countries where 4ever Multistrada warranty applies

MULTISTRADA V2

Ducati Red
with black rims and tags



MULTISTRADA V2S

Street Grey livery
with black frame and GP Red rims



Ducati Red
with black rims and tags



MULTISTRADA V2S

Street Grey livery
with black frame and GP Red rims
Travel equipment



Ducati Red
with black rims and tags
Travel equipment





Multistrada V2



Multistrada V2 S

Front Suspension	
Rear Suspension	
Ducati Quick Shift up/down (DQS)	○
Instrumentation	LCD display
Hands-free system	Unavailable
Backlit handlebar switches	Unavailable
Cruise Control	Unavailable
Full LED headlight	Unavailable
Ducati Cornering Lights (DCL)	Unavailable
Tyre Pressure Monitoring System	Unavailable
Dry weight	199 Kg (439 Lb)
Kerb weight*	222 Kg (489 Lb)

Ø 48 mm fully adjustable usd fork	
Fully adjustable monoshock, Remote spring preload adjustment, Aluminium double-sided swingarm	
○	
LCD display	
Unavailable	
Unavailable	
Unavailable	
Unavailable	
Unavailable	
Unavailable	
Unavailable	
199 Kg (439 Lb)	
222 Kg (489 Lb)	

Ø 48 mm fully adjustable usd fork, Electronic compression and rebound damping adjustment with Ducati Skyhook Suspension Evo	
Fully adjustable monoshock, Electronic compression, rebound damping and spring pre-load adjustment with Ducati Skyhook Suspension Evo, Aluminium double-sided swingarm	
●	
5" TFT colour display	
●	
●	
●	
●	
●	
●	
○	
202 Kg (445 Lb)	
225 Kg (496 Lb)	



1 Spoked wheel



2 5" TFT colour display

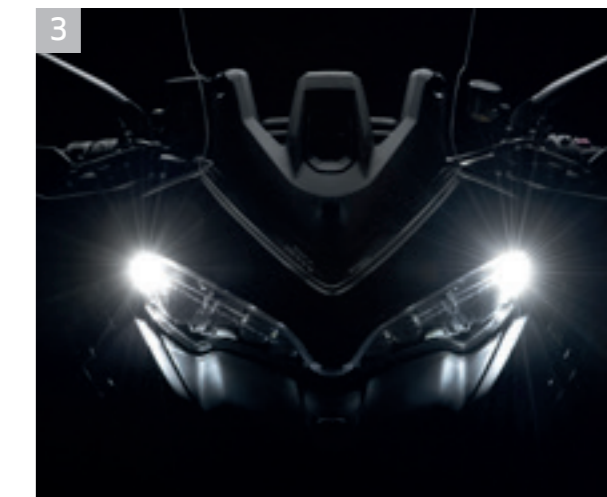

3 Full-LED headlight



4 Backlit handlebar



5 Ducati Quick Shift up/down (DQS)

● Standard ○ Optional accessory

* Only for countries where Euro 5 standard applies

Apparel

Tour C4

Fabric jacket
Fabric trousers

Horizon V2

Modular helmet

Ducatiana 2.0

T-shirt

All Terrain

Touring-Adventure Boots



Ducati Apparel Collection designed by *Drudi Performance*





Speed Evo
Full-face helmet

Fighter C1
Leather-fabric jacket

Company C3
Technical jeans

Sport C3
Leather-fabric gloves

Company C3
Technical short boots





48 | Multistrada V2

Tour C4

Fabric jacket

Horizon V2

Modular helmet

Logo

Round-neck sweatshirt

Ducatiana 2.0

T-shirt



ACCESSORIES

Configure the Ducati of your dreams.

Multistrada means optimum Ducati technology, performance, and comfort. To enjoy adventures and journeys of any distance, in all conditions and on any road.

Configure

Choose the ideal Multistrada V2 for you and have fun configuring it to suit your riding style! Share your Multistrada V2 with friends and send it to your Ducati dealer who will contact you for an online consultation to discuss the current offers that best suit your needs.

Save your configuration to return to it at any time.

Calculate your payment

Ducati Financial Services offers favourable solutions for the financing of every model in the Ducati range. Personalise your financing and calculate the monthly instalments. You can then contact your dealer and discuss the best way to see your dream come true!







Go to configurator



For more information about the Ducati Performance range, tech specs and instructions, refer to a Ducati dealer or visit the Accessories section of ducati.com

Ducati Digital Experience

A mission for every channel. Continuous updating on the innovation and passion for which our work stands out. We transform emotions into exclusive content. Just a click away.

Follow us on:

-  www.ducati.com
-  [@ducati](#)
-  [@DucatiMotor](#)
-  [Ducati Motor Holding](#)

-  [@ducati](#)
-  [Ducati Motor Holding](#)
-  [@ducati_official](#)

MyDucati App

MyDucati is the personal area for every Ducatista, offering a wide range of services accessible with a single login from both the web and the app. Explore all the features of the MyDucati world and enjoy a multi-channel, customised experience wherever you are.

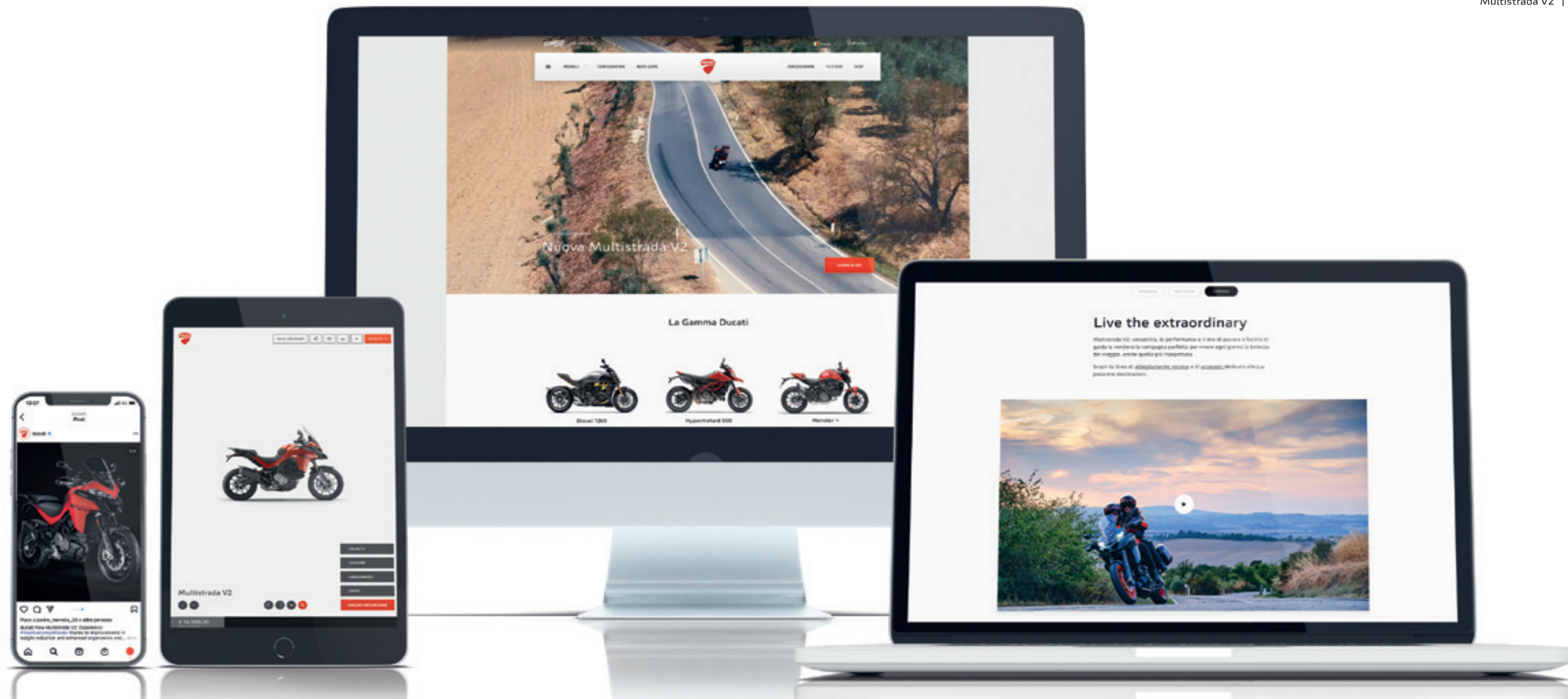

Riding a motorcycle is the most exciting way to enjoy the road, and offering the utmost safety to the motorcyclist is Ducati's commitment. Ducati bikes are increasingly easy to handle, reliable and better equipped to guarantee maximum safety and enhance riding pleasure. Technical clothing is made with more and more advanced materials for adequate protection and increased visibility. The safety of motorcyclists is Ducati's commitment. For more information visit the safety section of the Ducati site (www.ducati.com).

Warning: The photos and technical information in this catalogue may refer to prototypes subject to modifications during production and are purely for illustration and reference purposes, and are therefore not binding on Ducati Motor Holding S.p.A. Sole Shareholder Company - Company subject to the direction and coordination of AUDI AG ("Ducati"). Ducati cannot be held responsible for any print and/or translation errors. This catalogue is transnational and therefore some products may not be available and/or their features may vary in accordance with local laws. Not all colours and versions are available in each country. Ducati reserves the right to make changes and improvements to any product without obligation of prior notice or to make such changes to products already sold. Further characteristics of the products are contained in the pertinent owner's manuals. The products



ducati.com



represented are not definitive versions and are therefore subject to significant changes at Ducati's discretion without prior notice. The photographs published in this catalogue show only professional riders under controlled street conditions. Do not attempt to imitate such riding behaviour as it could be dangerous for you or other people on the road. This catalogue, including but not limited to the trademarks, logos, texts, images, graphics and table of contents herein, constitute Ducati intellectual property, or in any event Ducati has the right to reproduce it; any reproduction, modification or other whole or partial use of the catalogue or its contents, including publication on the Internet without the prior written consent of Ducati, is prohibited.

Actual fuel consumption may vary based on many factors, including but not limited to riding style, maintenance performed, weather conditions, surface characteristics, tyre pressure, load, weight of the rider and the passenger, accessories.

Ducati indicates the dry weight of the motorcycle excluding battery, lubricants and coolants for liquid-cooled models. The weights in running order are considered with all operating fluids, standard equipment and the fuel tank filled to 90% of its useful capacity (UE regulation no. 168/2013). For more information visit www.ducati.com.

November 2021

Developed with 

Technical partner 

Technical partner