

OWNER'S MANUAL

pulsar
125
BS VI



THE WORLD'S
FAVOURITE
INDIAN



To keep your bike in perfect running condition, please follow the periodic maintenance services which includes **3 Free and subsequent Paid services**, as per the schedule contained in this booklet.

अपनी बाइक को सही चलती हालत में रखने के लिए, कृपया आवधिक रखरखाव सेवाओं का पालन करें जिसमें **3 नि:शुल्क और बाद में भुगतान सेवाएं शामिल हैं**, इस पुस्तिका में दिए गए अनुसूची के प्रति।

आपली बाईक परिपूर्ण स्थितीत चालू ठेवण्यासाठी कृपया या बुकलेटमध्ये दिलेल्या शेड्यूलनुसार पीरिऑडिक मेन्टेनन्स सर्व्हिसेचे अनुकरण करा. **यात 3 फ्री आणि त्यानंतरच्या पेड सर्व्हिसेस समाविष्ट आहेत.**

ನಿಮ್ಮ ಬೈಕ್ ಸಂಪೂರ್ಣ ಚಾಲನಾ ಸ್ಥಿತಿಯಲ್ಲಿರಿಸಲು. ದಯವಿಟ್ಟು ಈ ಕ್ರಮದಿಯಲ್ಲಿ ನಮೂದಿಸಲಾದ ಶೆಡ್ಯೂಲ್ ನಂತೆ ನಿಯತಕಾಲಿಕ ನಿರ್ವಹಣಾ ಸೇವೆಗಳನ್ನು ಅನುಸರಿಸಿ. ಇವು 3 ಉಚಿತ ಮತ್ತು ನಂತರ ಪಾವತಿ ಸೇವೆಗಳನ್ನು ಒಳಗೊಂಡಿರುತ್ತವೆ.

உங்களுடைய பைக்கை மிக நன்றாக ஓடும் நிலையில் வைத்திருப்பதற்கு, இந்தக் கையேட்டில் கொடுக்கப்பட்ட அட்டவணையில் உள்ளவாறு 3, லவச மற்றும் தொடர்ச்சியான கூட்டண சேவைகளை உள்ளடக்கிய காலமுறை பராமரிப்பு சேவைகளை தயவு செய்து பின்பற்றவும்.

ಮಿ ಟ್ರಿಕಿ ಚಕ್ರವರ್ತಿ ರನ್ವಿಂಗ್ ಕಂಪೆನಿ ಲ್ಲೆ ಒಂದುಲಠಿ ಬುಕ್ ಲಿಫ್ಟ್ ಒನ್ನು ಪೆಡ್ಯೂಲ್ ಪ್ರಕಾರಂ ಕ್ರಮಂ ಕೆಚ್ಚುಕುಂಡು ಮಿಯಂಬೆನಿಸ್ಸಿ ನರ್ದಿಸುು ದೆಯುಂಡು, ಇಂದುಲ್ **3 ಒವಿತ ನರ್ದಿಸುುಲು, ಆ ಕರಾತುತೆ ವುಡುಡು ನರ್ದಿಸುುಲು ಕುಪ್ಪಾಯು.**

നിങ്ങളുടെ ബൈക്ക് തികഞ്ഞ റണ്ണിംഗ് കണ്ടീഷനില് സംരക്ഷിക്കാന് 3 സൗജന്യവും തുടര്ന്ന് പണം നല്കിയുള്ളതുമായ മെയ്ന്റനന്സ് സരവീസുകളുടെയുപായി സമയാസൂത്രം ഈ ബുക്ലെറ്റിലെ ക്രമപട്ടികയില് കാണിച്ചുപ്രകാരം പാലിക്കുക.

आपना बाइक वाइक निर्दलतावे चालू अवश्याय राखार जना, निर्दिष्ट समय अखर रक्षणवाखण परिसेवा अनुसरण करणार यार मथ्या आचे उटि विनामूला एवं परवती मूलाभितिक परिसेवा, अई पृथिकार अखर्कृत तालिका अनुयासी।

ଆପଣଙ୍କର ବାଇକ୍ ର ପୂର୍ଣ୍ଣ ରବି ଅବସ୍ଥାରେ ରଖିବା ପାଇଁ ପିରିଡିକ ମେନ୍ଟେନାନ୍ସ ସର୍ଭିସ୍ ର ଅନୁସରଣ କରନ୍ତୁ ଯାହା ଆପଣଙ୍କ ପାଇଁ 3 ଫ୍ରି ମାଣ୍ଟେନାନ୍ସ ଏବଂ ପରବର୍ତ୍ତୀ ମାଣ୍ଟେନାନ୍ସ ସର୍ଭିସ୍ ପାଇଁ ପାଠ୍ୟ ଦିଆଯାଇଛି ଏବଂ ପ୍ରତ୍ୟେକ ସର୍ଭିସ୍ ପାଇଁ ପ୍ରଦାନ କରାଯାଇଛି।

तमारी बाइकने संपूर्ण चालू स्थितीत मालवा माटे, कृपा करी नीचे मुद्रित समायांतरनी जालवणी सर्विसेजु पालन करे जेमां **उ मुफ्त अने पछी यूडवणी सर्विसेनी समावेश थाय अ**, आ पुस्तिकामां समाविष्ट समयक्रम मुद्रित।

आपची बाइक तुं चलती चालत विंच वधत लती, विरपा आवरती-संभाल सेवा पा चालन कते निम विंच **उ मुफ्त अने बाद विंच बुकलेट सेवा समावेश वत**, टिस विचअ विंच टिउते गटे अनुसूची ते पुटि।

ଆପୋନାର ବାइकचन सठिकभारे चलि थका छितत बाचिबले, अनुग्रह करि नियमीया तदुवारधान सेवा अनुसबण कबिब यत अखर्कृत थके **उ ती विनामूलीया आक उव पिछव परिसेवा कबा लेबा**, अई पृथिकानत अखर्कृत अनुसूची अनुसबि।

اپنی بائیک کو بہترین رنگ حالت میں رکھنے کے لیے، برائے مہربانی وقت سے اپنی مینٹیننس کی خادمانت پر عمل کریں جس میں شامل ہیں: اس کتابچے میں ڈنئے گئے وقت کے مطابق 3 مفت سروسز اور بعد کی پیڈ سروسز۔

Welcome to the Pulsar family!

You are now the proud owner of India's No.1 sports bike. By No.1 we are talking about unparalleled performance, superior technology and incredible market leadership that Pulsar today enjoys. This makes the Pulsar you ride, unbeatable and unchallenged both on and off the road.

Before you ride out, please read this Owner's Manual carefully and familiarize yourself with the operating mechanism, controls and maintenance requirements of your Pulsar. This will ensure you a safe and trouble free ownership experience.

To keep your bike in perfect running condition and deliver consistent performance, we have specially programmed the periodic maintenance services which includes 3 Free and subsequent Paid services, as per the schedule contained in this booklet. We earnestly advise you to avail all these services at any of our Bajaj Dealers or Authorised Service Dealers, who are well equipped with all necessary facilities / genuine parts / oil and trained manpower to ensure the best care for your Pulsar. Your **"Pulsar 125 BS VI"** comes with a warranty of **5 Years or 75,000 Kms** whichever occurs earlier from the date of sale. For details please refer to "Warranty : Scope & Limits" given in this manual.

Should you require any additional information feel free to contact us on our helpline numbers or e-mail us at: customerservice@bajajauto.co.in or visit the Bajaj Auto website www.bajajauto.com

To be a part of the Pulsarmania, visit www.mypulsar.com and join the Pulsar fanpage on facebook: www.facebook.com/mypulsar

Rev up, shift gears and enjoy the Pulsar experience...

SERVICE DEPARTMENT
BAJAJ AUTO LIMITED

Description

1. Technical Specifications	1
2. Identification Data	4
3. Location of Parts	5
4. Steering cum Ignition lock / Fuel Tap	6
5. Fuel Tank Cap & Instructions for Customers	7
6. Speedometer Details	8
7. Control Switches	9
8. Removal & Fitment of Side Covers	11
9. Removal & Fitment Seat	13
10. Battery / Tool kit	14
11. Daily Safety Checks	15
12. How to ride your Bike	16
13. Safe Riding Tips	20
14. Engine Oil	21
15. Wheels - Tyre	22
16. Periodic Maintenance Information	23
17. Periodic Maintenance & Lubrication Chart	26
18. Free Service Guidelines	34
19. Combined Braking System	35
20. Non Use Maintenance	36
21. Delivery Certificate	37
22. Warranty Scope & Limit	38
23. Battery Warranty Card	

Safety and Warning information :



Warning : This indicates that a potential hazard or injury to you or other persons & to the vehicle can happen if advice provided is not followed.



Caution : This indicates that a potential hazard that could result in vehicle damage. Follow the Advice provided with the caution.

Notice:

The description and illustration in this booklet are not to be taken as binding on the manufacturers. The essential features of the type described and illustrated herein remaining unaltered. Bajaj Auto Limited reserves the right to carry out at any moment without being obliged to bring this booklet upto-date & to do modifications on the vehicle, parts or accessories as may be convenient and necessary.

Technical Specifications



Parameter	Pulsar 125 Disc BS VI	Pulsar 125 Drum BS VI
Engine	4 stroke DTS-i, Single cylinder 2 valve	4 stroke DTS-i, Single cylinder 2 valve
Bore x Stroke	56 mm x 50.5 mm	56 mm x 50.5 mm
Displacement	124.38 cc	124.38 cc
Compression Ratio	10.22 +/- 0.3 :1	10.22 +/- 0.3 :1
Idling Speed	1400 +/- 100 RPM	1400 +/- 100 RPM
Max. Net Power	11.8 PS @ 8500 RPM	11.8 PS @ 8500 RPM
Max. Net Torque	10.8 Nm @ 6500 RPM	10.8 Nm @ 6500 RPM
Ignition System	DC	DC
Starting Aid	Self & Kick	Self & Kick
Spark Plug (2 nos.)	CHAMPION RG4HC	CHAMPION RG4HC
Spark Plug Gap	0.7~0.8 mm	0.7~0.8 mm
Transmission	5 speed constant mesh.(1 dn 4 up)	5 speed constant mesh.(1 dn 4 up)
Lubrication	Wet sump, Forced	Wet sump, Forced
Front Brake	Disc	Drum
Rear Brake	Drum	Drum
Tyre Front	80/100,17,46P,Tubeless	80/100,17,46P,Tubeless
Tyre Rear	100/90,17,55P,Tubeless	100/90,17,55P,Tubeless

Technical Specifications



Parameter	Pulsar 125 Disc BS VI	Pulsar 125 Drum BS VI
Tyre Pressure		
Front	1.75 kgf/cm ² (25 PSI)	1.75 kgf/cm ² (25 PSI)
Rear (Solo)	2 kgf/cm ² (28 PSI)	2 kgf/cm ² (28 PSI)
Rear (Pillion)	2.25 kgf/cm ² (32 PSI)	2.25 kgf/cm ² (32 PSI)
Fuel Tank		
Full	11.5 Liters	11.5 Liters
Reserve	2.5 Liters	2.5 Liters
Length	2055 mm (Single Seat), 2042 (Split Seat)	2055 mm (Single Seat), 2042 (Split Seat)
Width	765 mm	765 mm
Height	1060 mm	1060 mm
Wheel base	1320 mm	1320 mm
Ground Clearance	165 mm	165 mm
Electrical System	DC	DC
Head Lamp	35/35W	35/35W
Tail Lamp/Stop Lamp	LED	LED
Side Indicator	10W	10W
Horn	12V, 2A	12V, 2A

Parameter	Pulsar 125 Disc BS VI	Pulsar 125 Drum BS VI
Neutral Indicator	LED	LED
Turn Signal Indicator	LED	LED
Hi-Beam Indicator	LED	LED
Speedometer	LCD Display	LCD Display
Malfunction Indicator	LED	LED
Low Battery Indicator	LCD	LCD
Bajaj Logo	LED	LED
Fuel Level Indicator	LCD	LCD
Side Stand Indicator	LCD	LCD
Rear No. Plate Lamp	12V 5W	12V 5W
Battery	12V 4 Ah VRLA	12V 4 Ah VRLA
Vehicle Kerb Weight	140 kg.(Single Seat), 142 Kg (Split Seat)	140 kg.(Single Seat), 142 Kg (Split Seat)
Vehicle Gross Weight	290 kg.(Single Seat), 292 Kg (Split Seat)	290 kg.(Single Seat), 292 Kg (Split Seat)

- *This vehicle complies to BS VI standards.*
- *AHO is government regulation.*
- *All dimensions are under UNLADEN condition.*
- *Above information is subject to change without any notice.*

Identification Data

pulsar

The Frame and Engine serial numbers are used to register the motorcycle. They are the unique alpha-numeric codes to identify your particular vehicle from others of the same model and type.



Frame Number Location

On Side of Steering Tube
(Alpha-Numeric - 17 Digits)

Engine Number Location

On LH Side Crankcase Near Gear
Change Lever (Alpha-Numeric - 11 Digits)



Location of Parts

pulsar





To Lock the Steering : To lock the steering, turn the handle bar to the left or right. Push & release the key. Turn the key to “LOCK” position and remove the key.

To Unlock the Steering : To unlock steering, insert the key in steering cum ignition lock & turn it clockwise to “OFF” or “ON” position.

Key : A common key is used for ‘Steering cum Ignition lock’, ‘Fuel tank cap’ & ‘Side cover lock’.

Steering cum Ignition Lock :

It has three positions.

●	LOCK: Steering locked. Ignition OFF.
⊗	OFF: Steering unlock. Ignition OFF.
⊙	ON: Steering unlock. Ignition ON.

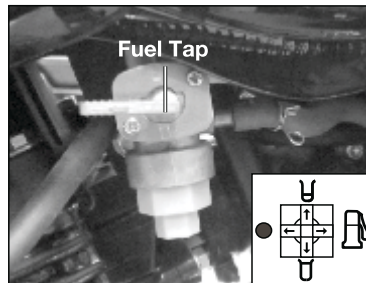

Fuel Tap

Fuel tap lever has following positions.

●	OFF : When fuel supply is to be cut off.
⊂	ON : When fuel level is above reserve position.
⊃	RES : When fuel level is below reserve position.



Fuel Tank Cap

- To open the fuel tank cap, open the flap. Insert the key in the lock and turn it clockwise and lift fuel tank cap.
- To lock the 'Fuel Tank Cap' insert the key in the lock and turn it clockwise and press fuel tank cap. 'Click' sound ensures cap is fully locked.

Precaution :
Dont attach metallic 'Key chain' as it may damage paint of petrol tank.

Instructions for Customers

- Do Not rev engine in standstill condition.
- Don't use adulterated fuel or fuel additives as it will result in rusting & clogging of engine parts.
- Never drive by disconnecting wheel speed sensor.
- Cleaning cloth to be strapped along with toolkit & to be kept under seat assy.



- Do not keep the cleaning cloth in the vicinity of high temperature zone e.g. Engine, Silencer,assy, Catalytic convertor, Starter motor, etc.

Speedometer Details

pulsar



- 1. Side Stand Indicator :** It glows when Side stand is down & ignition switch is 'ON'.
- 2. Fuel Level Indicator :** Fuel level indicator shows available fuel in fuel tank. Tank symbol glows when petrol level in tank reaches reserve level
- 3. Engine Rev Indicator :**It blinks when engine RPM cross 9500 RPM mark.
- 4. Tachometer Dial :** It shows engine speed in RPM.
- 5. Odometer :** The Odometer shows the total distance that the vehicle has accumulated.
- 6. Turn Indicator (LH & RH) :** When Turn signal switch is turned to L/R, Turn indicator - LH or RH will flash.
- 7. Speedometer:**Vehicle speed will be displayed digitally
- 8. Trip Meter Reset Button :** Both trip meters can be reset to zero by pressing the button.
- 9. Trip Meter :** The Trip meter shows the distance traveled since it was last reset to zero.
- 10. Battery Indicator :** It shows battery needs charging
- 11. Hi Beam Indicator :** It glows when Headlight is 'ON' & Hi beam is selected with engine running.
- 12. Neutral Indicator :** It glows when transmission is in Neutral & Ignition switch 'ON'
- 13. Malfunction Indicator () :** It glows whenever any abnormality is noticed in functioning of Ignition / BS VI carburettor components..

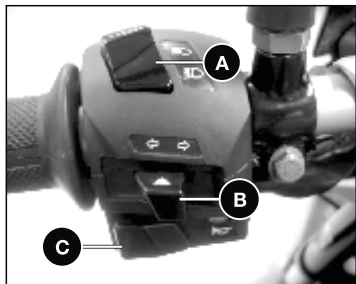

Left Handle Bar Switches

A. High/Low beam switch : When headlight is ON, High or Low beam can be selected with this switch. Hi beam indicator light located on Speedo console will light up when high beam is selected.

☰○ : High Beam ☷○ : Low beam

B. Turn Signal Switch : When the turn signal knob is turned to Left () or Right () respective indicator will start blinking, to stop blinking push the knob in & release.



C. Horn Button : () Press button for sounding horn.

D. Pass Switch : Press the switch to flash the head light. It is used to give signal to vehicles coming from opposite side while overtaking.

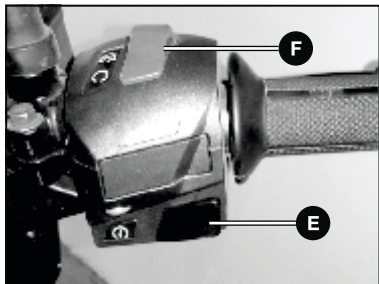

Right Handle Bar Switches

E. Starter Button :

Starter button operates the electric starter. It is recommended to start the engine with the transmission in neutral.

Vehicle in Gear - Press clutch lever & operate starter button to start the engine.

F. Engine Kill Switch :

The engine kill switch is used for switching ON & OFF the engine.

 : Engine OFF

 : Engine ON

AHO Feature (Automatic Headlight 'ON')

There is no 'Light switch' on RH control switch.

Ignition switch 'ON' Engine 'ON'	Speedometer illumination Tail lamp, Number Plate Lamp, Pilot Lamp & Control Switches Illumination will get 'ON'
Effect of pressing 'Pass Switch'	In addition to above Hi-beam will get 'ON'

Ignition switch 'ON' & Engine Running

Speedometer illumination, Tail lamp, Number Plate Lamp, Pilot Lamp & Control Switches Illumination will get 'ON'
in addition to above, headlamp will get on as given below.



Hi/Low beam Switch	Headlamp Status	Effect of Pass Switch
Low beam 	Low beam 'ON'	Hi beam 'ON'
Hi beam 	Hi beam 'ON'	No change



Fig. Side Cover LH

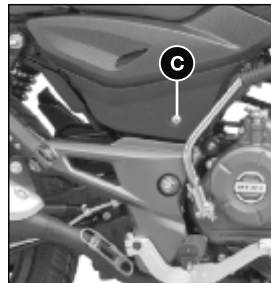
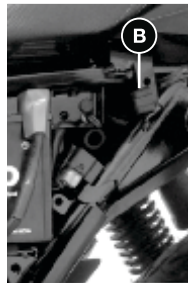
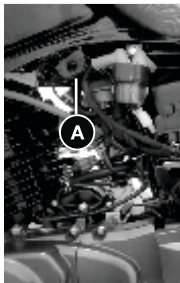

Fig. Side Cover RH

Removal of Side Cover LH

- Insert key into the cover lock & turn clockwise and pull the 'Side Cover' out from the bottom.
- Pull front portion of 'Side Cover' to release its Lug from hole **(A)** of 'Fuel Tank'.
- Slide the 'Side Cover' forward (towards the engine) to release slot provided on its rear end from 'bracket with rubber cap' **(B)** provided on 'Chassis'.
- Take out side cover.

Removal of Side Cover RH

- Remove the screw **(C)** securing the 'Side Cover RH'.
- Pull front portion of 'Side Cover' to release its Lug from hole **(A)** of 'Fuel Tank'.
- Slide the 'Side Cover' forward to release slot provided on rear end of 'Side Cover' from 'bracket' **(B)** provided on 'Chassis'.
- Take out side cover.



CAUTION : Remove cover as described above, Otherwise the lugs may break.

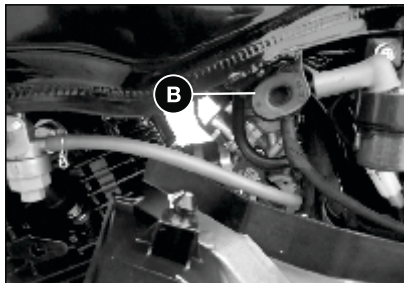

Fitment of Side Cover LH

- Match slot provided on rear end of 'Side Cover' with bracket **(A)** provided on 'Chassis' and slide 'Side Cover' backward (towards Tail lamp).
- Match Lug provided on front portion of 'Side Cover' with hole **(B)** provided on 'Fuel Tank' and press 'Side Cover' inside.
- Match the lock plate of 'Side Cover' properly with bracket on 'Chassis' and rotate key in clockwise direction to lock.

Fitment of Side Cover RH

- Match slot provided on rear end of 'Side Cover' with bracket **(A)** provided on 'Chassis' and slide 'Side Cover' backward
- Match Lug provided on front portion of 'Side Cover' with hole **(B)** provided on 'Fuel Tank' and press 'Side Cover' inside.
- Match 'Side Cover RH' properly with bracket provided on 'Air filter assly' & fix it with Screw.



CAUTION : Fit cover as described above to ensure proper fitment.



Seat Release Cable

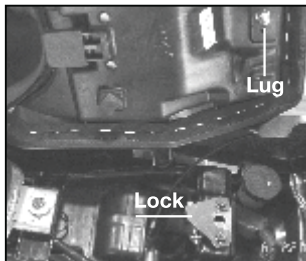

Fig. B

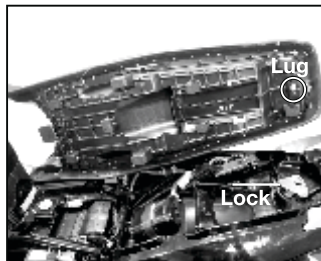



Fig. C

Removal of Seat- Front & Rear (Split seat model)

- Remove 'Side Cover' LH.
- Pull rear seat lock cable (A) & remove 'Rear Seat'
- Similarly pull the front seat lock cable (B) & remove 'Front Seat'.

 **CAUTION:** Always remove Rear seat first.

Follow procedure as given below-Single seat

Removal of Seat assembly complete

- Remove 'Side Cover' LH.
- Pull seat lock cable (A) & remove the seat complete.

Fitment of Seat- Front & Rear (Split seat model)

- Both the seats can be fitted by matching their lug with the respective lock & pressing down the lug into lock.

 **CAUTION :** Always fit Front seat first.

Follow procedure as given below-Single seat

Fitment of Seat assembly complete

- The seat assembly can be fitted by matching its lug with the lock & pressing down the lug into the lock.



Battery

- It is located inside the 'Side Cover' LH.
- Always keep a watch on battery charge level indicating icon, if it flashes (indicates battery is in low charged condition), show the vehicle to authorised BAL dealer.
- Make of battery may differ from vehicle to vehicle

 **CAUTION :** Do not drive/run vehicle in battery disconnected condition. It may lead to damage of electrical / electronic components.

First Aid Kit Location

- First aid kit is to be stored in seat cowl.

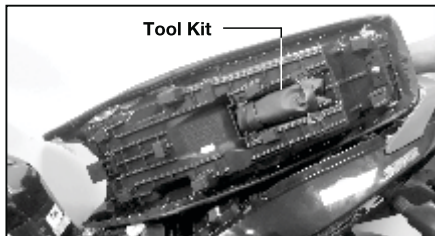

Tool Kit Location

- It is located below the battery.
- 2 rubber straps are provided to hold the tool kit.



CAUTION :



- Always fit rubber strap for locking tool kit.
- Cleaning cloth to be strapped along with tool kit under seat assy.

Before riding motorcycle be sure to check following items. Please give proper importance to these checks and perform all of them before riding motorcycle.



If any irregularities are found during these checks, refer to the Maintenance chapter & see your dealer for the action required to return the motorcycle to a safe operating condition.

 **Warning** : Failure to perform these checks every day before you ride may result in serious damage or severe accident.

- Enough **fuel level** for planned distance of journey. No fuel leakage in fuel lines.
- **Engine oil** level (between upper and lower level mark)
- **Throttle cable** play of 2 ~ 3 mm. Smooth operation and positive return to closed position,
- **Front Brake Cable** Free play 2 ~ 3 mm for Drum-Drum CBS version.

- **Brake Pedal** Play-Drum Brake 20 to 30mm
Disc Brake-Fixed
- **Wear lining Indicator** within usable range. No brake dragging, applicable to drum brake vehicles.
- **Brake Fluid** level above MIN mark provided on reservoir, applicable to disc brake vehicle.
- **Drive Chain** slack of 20 to 30 mm adequately lubricated.
- Function of all **lights & horn**
- **Clutch lever** play - 2 to 3 mm
- Smooth **steering movement** without restriction.
- Both **stand** return to their fully up position.
- Correct **inflation pressure** in both tyres
Adequate tyre tread depth - no cracks / cuts.
- Correct **rear viewing** span adjustment of mirror.

Starting The Engine :

- Turn the fuel tap knob to  or  position.
- Turn ignition switch key to '  ' position.
- Confirm that transmission is in neutral.
- **Keep throttle completely closed.** operate self start button or apply kick to start the engine.
- Release kick as soon as engine starts.

Note : Before starting the engine, in ignition key off condition, press the clutch lever & operate kick lever all the way down for 5-6 times. Then release the clutch lever.

This practice ensures lubrication of clutch components for their longer life.

 **Caution :** Do not operate the starter continuously for more than 5 seconds otherwise battery would get discharged. Wait 15 sec. between each operation of the starter which will facilitate battery to recover.

Note : Do not touch / disturb setting of idling & air screw provided on BS VI carburettor. If required take the vehicle to workshop or authorised service dealer.

Note : The motorcycle is equipped with a clutch switch. This switch ensures that engine does not start if the transmission is in gear. However, the engine can be started in any gear if the clutch lever is pressed.

This vehicle is equipped with BS VI carburettor having Auto choke. The control unit operates ON / OFF function of Auto Choke. No manual operation is required. Auto choke ensures smooth starting of

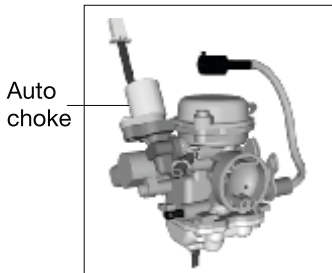

Shifting Gears :

- Close throttle & depress the clutch.
- Shift into next higher or lower gear.
- Open the throttle and release the clutch lever slowly and simultaneously.

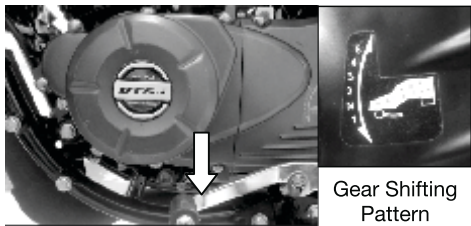

Gear Shifting Lever

Gear Shifting Pattern

Recommended Speed for Shifting Down

From 5 th to 4 th Gear	45 km/h
From 4 th to 3 rd Gear	35 km/h
From 3 rd to 2 nd Gear	25 km/h
From 2 nd to 1 st Gear	15 km/h



Warning : When shifting down to lower gear, do not shift at such high speed that engine rpm jumps excessively. This may cause engine damage, & rear wheel may skid. Downshifting should be done at recommended speeds as shown in table.

Braking :

- Close throttle completely, leaving clutch engaged (except where shifting gears) so that engine braking will help slow down motorcycle.
- Shift down one gear at a time so that you are in Neutral when you come to a complete stop.
- Front brake is to be used to get maximum braking performance.
- Rear brake is to be used when more deceleration is required.
- When stopping, always apply both brakes at the same time. De-clutch as necessary to avoid engine stalling.

Stopping the Vehicle :

- Close the throttle completely.
- Shift the transmission into neutral.
- Bring the vehicle to complete stop.
- Turn the ignition switch off.

Parking the Vehicle :

- Support the motorcycle on a firm level surface with the center or side stand.
- Lock the steering.

 **CAUTION :** Do not park on a soft or steeply inclined surface or the motorcycle may fall over.

Whenever vehicle is falls down, remove plug of 'Y connector drain tube' & drain out accumulated petrol

Running IN

Proper running-in is important for the better life & trouble free performance of the vehicle.

- During first 2000 kms running-in period do not exceed following speed limits.

Kms	1st	2nd	3rd	4th	5th
0 - 1000	10	20	30	35	45
1000 - 2000	15	30	40	45	55

- Always keep the speed below the limits mentioned in the table.
- Do not race the engine excessively.
- Do not start moving or race the engine immediately after starting. Run the engine for a minute at idle speed to give the oil a chance to workup into the engine.

Moving Off :

- Check that Center/Side stand is up.
- Depress the clutch lever.
- Shift into 1st gear.
- Open the throttle and release the clutch lever slowly and simultaneously.
- As the clutch starts to engage, open the throttle a little more, giving the engine just enough rpm to keep it from stalling.

Fuel Saving Tips :

A well maintained vehicle and good driving can contribute a lot to the saving of petrol. Following are a few simple fuel saving tips.

Good Riding Habits :

- Ride smoothly and steadily at an optimum driving speed of 40 to 50 Km/h
- Avoid harsh braking.
- Change the gear judiciously according to the speed and load requirement.
- Don't overload the vehicle above the specified payload.
- Use the accelerator judiciously.
- Cut off the engine if you want to stop for more than two minutes.

How to check mileage (Fuel efficiency)

Best way to calculate mileage is by following the full tank to full tank method.

- Fill way tank full up to small mouth (brim).
- Run the bike for say 100 km.
- Fill the tank full again in same fuel filling station, probably with same fuel dispenser.
- Divide kilometer run / fuel quantity filled.

Ensure following maintenance points to get optimum performance from your bike.

Fuel	Check fuel lines & connections for leakage.
Spark Plugs	Inspect and clean spark plugs. Adjust electrode gap. Replace spark plugs as per P.M. Chart.
Air Filter	Clean the air filter element periodically. Replace as per Periodic Maintenance Chart.
Engine Oil	Check engine oil level. Always use recommended grade and quantity.
Brakes	Ensure that the brakes are not dragging / binding.
Clutch	Ensure correct clutch lever play.
Tyre Air Pressure	Always maintain recommended tyre pressure.
Carburettor	Clean float chamber bowl of the carburettor.

Safe Riding Tips

- Always wear Helmet while driving or riding. Your helmet should conform to appropriate Indian standards.
- Read thoroughly the instructions given in this manual and follow them carefully.
- Avoid unnecessary accessories for the safety of both rider and other motorists.
- Get familiar and follow traffic rules & regulations in your states as well as general traffic signs.
- Familiarise yourself well with starting, acceleration and braking of the vehicle.
- When applying the brakes, use both front & rear brakes simultaneously. Applying only one brake may cause the vehicle to lose control.
- Riding at proper speed and avoiding unnecessary acceleration and braking are important not only for safety and low fuel consumption, but also for longer life of the vehicle.
- During monsoon, drive the vehicle more cautiously. Remember vehicle skid more easily during light showers.



- It is suggested to customer to take appropriate care in area of heavy monsoon or high rainfall area. The appropriate surface preventive coat to avoid rusting / poor surface finish on account of adverse atmospheric conditions.
- Always carry vehicle registration & insurance papers, and a valid driving licence with you.

General Maintenance Tips :

- Vehicle cleaning to be done with soft & clean wet cloth to avoid scratches on painted parts.
- Clean & lubricate all the important parts as detailed in a periodic maintenance chart.
- Do not apply direct water jet on painted, electrical / electronic parts.
- Do not obstruct engine cooling by adding mud protection sheet from front
- Drive cautiously. Start early & reach your destination safely.
- Avoid driving on loose sand or stones where vehicle is likely to skid.
- Properly wrap-up loose clothes while driving or riding to avoid entangling in wheel or other objects on road.
- Always concentrate on riding for safety.

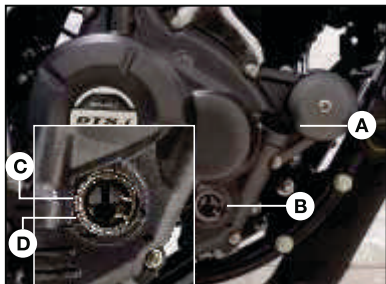

A : Oil Filler Cap, B : Oil Level Gauge

Engine Oil Level Checking :

- Check engine oil level every day. Park vehicle on level surface on centre stand.
- Check oil level through oil level gauge 'B'.
- Always maintain engine oil level between upper (C) and lower (D) mark provided on Cover RH. Top up with specified grade of oil if the oil level is below lower level mark.

Engine Oil Capacity :

- Refill at servicing : 1000 ml.
- During engine overhaul : 1100 ml.

Recommended Engine Oil:

Always insist on Bajaj Genuine Engine Oil for optimum engine performance and to avail warranty benefits. It is a specially formulated oil for Bajaj motorcycles.

Model	Recommended Engine oil	Grade
Pulsar 125	BAJAJ DTS-i 10000 BS6 Compliant	10W30 JASO MA2 API SN

- Engine oil replacement frequency : 1 service & then every 10,000 Km.
- Engine oil level top-up frequency : Every 5000 km.
- For all BS6 Vehicles, BS6 compatible engine oil is to be used only. Use of BS6 compliant engine oil will give prolonged life of catalytic converter.



CAUTION :

- It is most important to adhere to recommended grade & frequency of oil change for the purpose of long life of critical engine components. For details, refer periodic maintenance chart.
- Do not reuse drained engine oil.



Tubeless Tyre :

The main advantage of tubeless tyres is in case of puncture the rate of air leak is very slow, hence customer can easily drive the vehicle upto nearest puncture repair shop for removing puncture.

! **CAUTION :** Tubeless tyres are fitted in this motorcycle. The walls of the tyres in contact with the wheel rim should not be damaged in any way during fitment / removal of tyre. The tyre side walls in contact with wheel rim seals air.

Wheel Puncture:

- Visit nearest known tubeless tyre repair shop to remove puncture.
- Remove puncture by Filler or Plug method
- Do not use patch method to remove puncture of tubeless tyre.

Tyre Pressure :

Keep appropriate tyre pressure as mentioned below to increase life of the tyre & for better fuel consumption.

Front	1.75 Kgf/cm ² (25 PSI)
Rear (Solo)	2 kgf/cm ² (28 PSI)
Rear (with Pillion)	2.25 kgf/cm ² (32 PSI)

Note : *Incase the motorcycle is fitted with imported tyres. compliance to respective indian standard & central motor vehicle rules has been ensured.*

- Tyre warranty is settled by tyre manufacturer.
- Decision is taken based on tyre wear and running of vehicle.
- BAL settles tyre warranty only for imported tyres.



Disc-Drum version

Front Brake Fluid Level :

- Front brake fluid reservoir is located on RH side of Handle bar.
- To check oil level, keep the vehicle on center stand with handle bar in straight ahead condition.
- Always ensure that brake fluid level is above 'MIN' mark given on inspection Window.



Battery : 12V, 4 Ah VRLA

Battery Features :

- No topping-up is required
- Reduced self discharge, Enhance safety.
- No vent tube open to atmosphere hence no discharge of electrolyte through vent tube.
- Environment care must be taken to dispose off the used battery. It is always recommended to hand over the same to the Authorised battery / Bajaj dealer for proper disposal of the same.
- When battery is found discharged, it is advised to get it charged immediately.
- Warranty on battery is 18 months from the date of purchase of vehicle.

CAUTION : Do not drive/run vehicle in battery disconnected condition. It may lead to damage of electrical /electronic components.

How to keep battery healthy ?

- Switch 'Off' ignition when engine is not running.
- Get battery checked / charged during periodic services.
- Do not press starter button for more than 5 sec. After 3 successive cranking, wait for 15-20 sec. for battery to recover.
- **Do not add extra electrical accessories such as - Remote, Bigger horn, Musical brake light etc. This will reduce life of battery**
- If vehicle is to be stored for more than 2 weeks disconnect battery to avoid self discharge.

CAUTION :

- While disconnecting always disconnect negative (-ve) cable first.
- While refitting always connect positive (+ve) cable first.

Spark Plug

- Remove spark plugs by using plug spanner.
- Clean the spark plugs.
- Adjust the gaps if incorrect by bending outer electrode carefully.

Spark Plug Gap : 0.7 to 0.8 mm.

Spark Plug (2 Nos.) : CHAMPION RG4HC

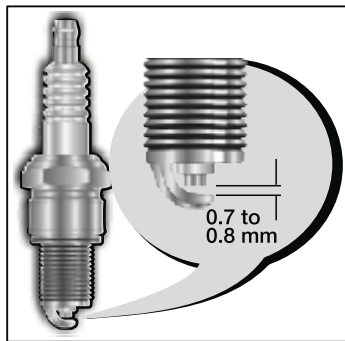

Drive Chain Slackness

- Chain top edge to be kept between the two marks during chain slackness adjustment.
- Chain slackness will have to be adjusted whenever required.
- Std. Chain slackness 20 ~ 30 mm.
- Marking on chain adjusters should be identically positioned on both sides.

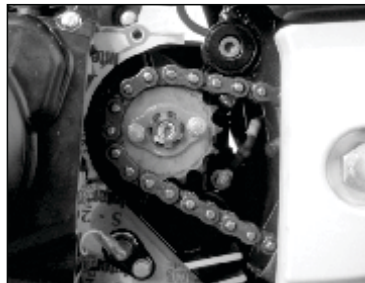

Drive Chain Cleaning & Lubrication

Drive chain must be cleaned & lubricated as per periodic maintenance schedule.

a. Drive chain (Non O-ring type)

- Non O-ring type chain should be removed & cleaned by Nylon brush & Kerosene or in Chain Cleaning Machine.
- It should be lubricated by SAE 90 grade oil.

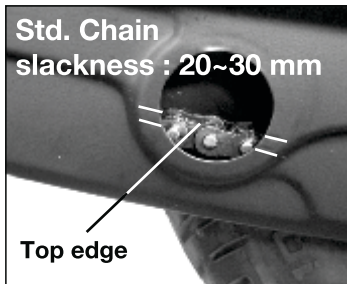

Periodic Maintenance & Lubrication Chart



Sr. No.	Activities / Check points	Recommended frequency - Service interval & Kms							
		Servicing	1st (Free)	2nd (Free)	3rd	4th	5th	6th	7th
		KMS	500 750	4500 5000	9500 10000	14500 15000	19500 20000	24500 25000	29500 30000
1.	Servicing with water wash	✓	✓	✓	✓	✓	✓	✓	✓
2.	Engine oil (Bajaj DTSI 10000 oil)	Top-up,R	R	Top-up	R	Top-up	R	Top-up	R
3.	Oil strainer	CL	CL		CL		CL		CL
4.	Centrifugal oil filter	CL	CL		CL		CL		CL
5.	Air cleaner element** & air filter cover 'O' ring. Drain tube cleaning.	CL	CL	CL	CL	R	CL	CL	R
6.	Fuel cock sediment bowl cleaning**	CL				CL			CL
7.	Fuel pipes for cracks.	C,R	C	C	C	R	C	C	R
8.	Spark plug clean & check gap	CL,A,R			CL,A		CL,A		R
9.	Valve tappet clearance	C, A	C, A	C, A	C, A	C, A	C, A	C, A	C, A
10.	Carburettor float chamber cleaning**	CL				CL			CL
11.	Carburettor rubber duct (Sleeve) for hard resulting in loose fitment.	C,R				C,R	C,R	C,R	C,R
12.	Engine breather tube for cracks.	C,R			C,R	C,R	C,R	C,R	C,R
13.	EVAP system Hoses- check for cracks	C,R		C,R	C,R	C,R	C,R	C,R	C,R

Periodic Maintenance & Lubrication Chart



Recommended frequency - Service interval & Kms									Remarks
8th	9th	10th	11th	12th	13th	14th	15th	16th	
34500	39500	44500	49500	54500	59500	64500	69500	74500	
35000	40000	45000	50000	55000	60000	65000	70000	75000	
✓	✓	✓	✓	✓	✓	✓	✓	✓	Ensure to prevent water entry in Petrol tank, Silencer & electrical parts. Use caustic free detergent for washing.
Top-up	R	Top-up	R	Top-up	R	Top-up	R	Top-up	Use BGO 10W30Oil level window cleaning at every 10000 kms by petrol spray & nylon brush.
	CL		CL		CL		CL		Oil strainer cleaning at the time of oil change. Replace clutch cover gasket
	CL		CL		CL		CL		Clean body centrifugal filter at 1st free service & at 10,000 kms
CL	CL	R	CL	CL	R	CL	CL	R	Replace air filter element at every 15000 kms Replace air filter cover O ring along with air filter element
		CL			CL			CL	
C	C	R	C	C	R	C	C	R	Replace at every 15000 kms
	CL,A		CL,A		R		CL,A		Replace at every 30000 kms
C, A	C, A	C, A	C, A	C, A	C, A	C, A	C, A	C, A	
		CL			CL			CL	
C,R	C,R	C,R	C,R	C,R	C,R	C,R	C,R	C,R	Replace if required
C,R	C,R	C,R	C,R	C,R	C,R	C,R	C,R	C,R	Replace if required
C,R	C,R	C,R	C,R	C,R	C,R	C,R	C,R	C,R	Drain EVAP "Y" connection drain tube. Replace if found cut/damaged

Periodic Maintenance & Lubrication Chart



Sr. No.	Activities / Check points	Recommended frequency - Service interval & Kms							
		Servicing	1st (Free)	2nd (Free)	3rd	4th	5th	6th	7th
		KMS	500 750	4500 5000	9500 10000	14500 15000	19500 20000	24500 25000	29500 30000
14.	Engine foundation silent bushes for cracks	C,R			C,R		C,R		C,R
15.	Silencer drain hole cleaning	CL			CL	CL	CL	CL	CL
16.	Wiring harness connections, routine & Conduit / PVC sleeve inspection.	C,A,T	C,A,T	C,A,T	C,A,T	C,A,T	C,A,T	C,A,T	C,A,T
17.	Battery , connections & health by load tester. +ve terminal cap fitment.	C,A,L,T	C,A,L,T	C,A,L,T	C,A,L,T	C,A,L,T	C,A,L,T	C,A,L,T	C,A,L,T
18.	Ignition switch contacts cleaning	CL,L			CL,L	CL,L	CL,L	CL,L	CL,L
19.	HT coil connections (Primary and Secondary)	C,T		C,T	C,T	C,T	C,T	C,T	C,T
20.	Starter motor & starter relay connections	C,T		C,T	C,T	C,T	C,T	C,T	C,T
21.	Check fault code, Clear fault history, Update latest hex file if applicable	C	C	C	C	C	C	C	C
22.	Non- sealed Drive chain wear**- Clean, Lubricate & adjust. Replace if required	CL,L,A	CL,L,A	CL,L,A	CL,L,A	CL,L,A	CL,L,A	CL,L,A	CL,L,A
23.	Drive chain link lock	R					R		
24.	Main stand & side stand both pivot pin	C,L					C,L		
25.	Steering play	C,A	C,A	C,A	C,A	C,A	C,A	C,A	C,A
26.	Steering stem bearing & Cap steering bearing (Plastic)**	C,CL,L			C,CL,L		C,CL,L		C,CL,L
27.	Front fork oil & seal	C,R	C,R	C,R	C,R	C,R	C,R	C,R	C,R

Periodic Maintenance & Lubrication Chart



Recommended frequency - Service interval & Kms									Remarks
8th	9th	10th	11th	12th	13th	14th	15th	16th	
34500	39500	44500	49500	54500	59500	64500	69500	74500	
35000	40000	45000	50000	55000	60000	65000	70000	75000	
	C,R		C,R		C,R		C,R		Replace if required
CL	CL	CL	CL	CL	CL	CL	CL	CL	
C,A,T	C,A,T	C,A,T	C,A,T	C,A,T	C,A,T	C,A,T	C,A,T	C,A,T	Damaged conduit / PVC sleeves protection by applying electrical tape film
C,A,L,T	C,A,L,T	C,A,L,T	C,A,L,T	C,A,L,T	C,A,L,T	C,A,L,T	C,A,L,T	C,A,L,T	Apply petroleum jelly on battery terminals Use Midronics battery tester.
CL,L	CL,L	CL,L	CL,L	CL,L	CL,L	CL,L	CL,L	CL,L	Use recommended WD40 spray
C,T	C,T	C,T	C,T	C,T	C,T	C,T	C,T	C,T	
C,T	C,T	C,T	C,T	C,T	C,T	C,T	C,T	C,T	
C	C	C	C	C	C	C	C	C	
CL,L,A	CL,L,A	CL,L,A	CL,L,A	CL,L,A	CL,L,A	CL,L,A	CL,L,A	CL,L,A	During 1st Free Service :Use lint free cloth for cleaning & SAE 90 oil for lubrication without removing from vehicle. During all other services: Remove, Clean by Diesel & Lubricate using molten chain grease.
	R				R				Replace at every 20000 kms
	C,L				C,L				Use recommended AP grease.
C,A	C,A	C,A	C,A	C,A	C,A	C,A	C,A	C,A	
	C,CL,L		C,CL,L		C,CL,L		C,CL,L		Replace if required.Use Limoplex grease for lubrication
C,R	C,R	C,R	C,R	C,R	C,R	C,R	C,R	C,R	Replace oil and oil seal + dust seal in pair at every 30000kms

Periodic Maintenance & Lubrication Chart



Sr. No.	Activities / Check points	Recommended frequency - Service interval & Kms							
		Servicing	1st (Free)	2nd (Free)	3rd (Free)	4th	5th	6th	7th
		KMS	500 750	4500 5000	9500 10000	14500 15000	19500 20000	24500 25000	29500 30000
28.	Swing arm pivot pin	L				L			L
29.	Brake shoes or pads for wear limit.	C,R	C,R	C,R	C,R	R	C,R	C,R	R
30.	Rear brake cam	CL,L		CL,L	CL,L	CL,L	CL,L	CL,L	CL,L
31.	Check source of leakages if any in the brake system. Check Front & rear brake hose condition. Check Brake fluid level and top up, if needed.	C,A,R	C,A,R	C,A,R	C,A,R	C,A,R	C,A,R	C,A,R	R
32.	Rear sprocket fasteners for looseness.	C,T	C,T		C,T		C,T		C,T
33.	Rear wheel rubber shock dampers for excess play.	C,R			C,R		C,R		C,R
34.	Fairing & windshield well nuts for rubber cracks.	C,R			C,R	C,R	C,R	C,R	C,R
35.	Clutch, Throttle, Front brake cables & brake pedal free play adjustment	C,A	C,A	C,A	C,A	C,A	C,A	C,A	C,A
36.	Head light focus adjustment	C,A	C,A	C,A	C,A	C,A	C,A	C,A	C,A
37.	Check & confirm all bulbs / switches working.	C,A	C,A	C,A	C,A	C,A	C,A	C,A	C,A
38.	General lubrication – Clutch lever / front brake lever & kick lever, rear brake lever	L	L	L	L	L	L	L	L
39.	Tyre air pressure.	C,A	C,A	C,A	C,A	C,A	C,A	C,A	C,A

Periodic Maintenance & Lubrication Chart



Recommended frequency - Service interval & Kms									Remarks
8th	9th	10th	11th	12th	13th	14th	15th	16th	
34500 35000	39500 40000	44500 45000	49500 50000	54500 55000	59500 60000	64500 65000	69500 70000	74500 75000	
		L			L			L	Replace ball & plate, if required.
C,R	C,R	R	C,R	C,R	R	C,R	C,R	R	Replace at every 15000 Kms
CL,L	CL,L	CL,L	CL,L	CL,L	CL,L	CL,L	CL,L	CL,L	Use AP grease.
C,A,R	C,A,R	C,A,R	C,A,R	C,A,R	C,A,R	C,A,R	C,A,R	C,A,R	Check & Top up DOT 4 brake oil in every service. Replace DOT 4 brake oil & Master / Caliper seals at every 30000 kms
	C,T		C,T		C,T		C,T		Use model wise torque values.
	C,R		C,R		C,R		C,R		Replace rear wheel rubber shock damper if required
C,R	C,R	C,R	C,R	C,R	C,R	C,R	C,R	C,R	Replace if required.
C,A	C,A	C,A	C,A	C,A	C,A	C,A	C,A	C,A	Replace cables if operation found hard.
C,A	C,A	C,A	C,A	C,A	C,A	C,A	C,A	C,A	
C,A	C,A	C,A	C,A	C,A	C,A	C,A	C,A	C,A	Contact type switches if found sticky then use recommended WD40 spray
L	L	L	L	L	L	L	L	L	Use recommended AP grease.
C,A	C,A	C,A	C,A	C,A	C,A	C,A	C,A	C,A	Ensure model wise tyre air pressure.

Periodic Maintenance & Lubrication Chart



Sr. No.	Activities / Check points	Recommended frequency - Service interval & Kms							
		Servicing	1st (Free)	2nd (Free)	3rd	4th	5th	6th	7th
		KMS	500 750	4500 5000	9500 10000	14500 15000	19500 20000	24500 25000	29500 30000
40.	Mirror position & joint firmness.	C,A	C,A	C,A	C,A	C,A	C,A	C,A	C,A
41.	All fasteners tightness, few are, Front & rear axle, Swing arm axle, Engine foundation, Rider foot rest, Pillion stay	C,T	C,T	C,T	C,T	C,T	C,T	C,T	C,T

**** More frequent cleaning may be required while driving in dusty environment.**

C : Check, A : Adjust, CL : Clean, R : Replace, T : Tighten, L : Lubricate

Note : Periodic parts, Oil, Filters, All types of greases, Cleaning agents, Cables, Wear & tear parts, Rubber 'O' rings / oil seals / pipes, Gaskets to be replaced as per Periodic Maintenance and Lubrication Chart are mandatory and the same are chargeable to customer.

Periodic Maintenance & Lubrication Chart



Recommended frequency - Service interval & Kms									Remarks
8th	9th	10th	11th	12th	13th	14th	15th	16th	
34500	39500	44500	49500	54500	59500	64500	69500	74500	
35000	40000	45000	50000	55000	60000	65000	70000	75000	
C,A	C,A	C,A	C,A	C,A	C,A	C,A	C,A	C,A	
C,T	C,T	C,T	C,T	C,T	C,T	C,T	C,T	C,T	Use model wise torque values.

Instruction to avail Free Service through Digitized Free Service Coupon

Please follow following procedure : -

- Please provide your mobile number to Dealer at the time of buying of new Bajaj Vehicle.
- In case of change in mobile number, please update to Dealer / ASD.
- When you are at Dealership / ASD workshop for availing Free Service, you will receive the 'Unique Coupon Number' (UCN) through SMS in your mobile.
- Please inform the UCN to Dealer / ASD at the time of Free Service.
(ASD-Authorised Service Dealer)

Periodic Service Criteria			
Service	Days	Kms	
1st Free Service	30~45	500~750	whichever occurs earlier
2nd Free Service	240	4500~5000	
3rd Free Service	360	9500~10000	
Subsequent Paid services	120 Days from last Service	Every 5000 Km after previous service	

Availing all Free / Paid Services, replacing mandatory periodic parts & engine oil will entitle warranty eligibility.

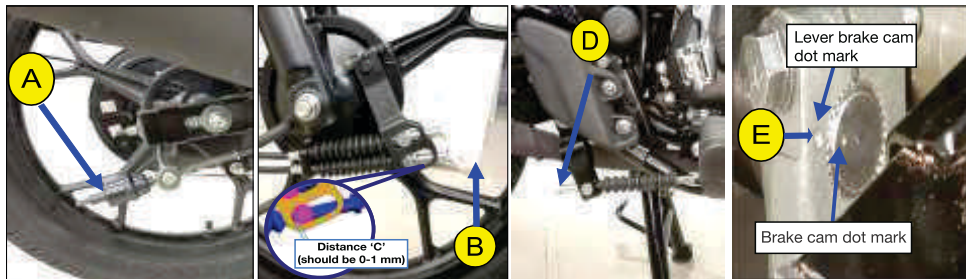

CBS Working :

- When front brake lever is pressed, then only front brake will get applied.
- When Rear brake pedal is pressed then both Rear and Front brake are applied, however it is recommended to use both brakes simultaneously for best braking performance

Brake setting guideline in case rear wheel puncture and repair done at road side garage.

- Adjust rear brake free play by tightening force distribution unit 'A' . After adjustment ensure gap between CBS front brake cable 2 (B) sleeve & cam lever slot (Distance C) and do not over tighten adjuster nut (D).
- It is recommended to do setting as per guideline at authorised dealership after rear / front wheel puncture, rear / front brake shoe replacement, CBS cable replacement, higher brake free play at rear / front, chain play adjustment, tyre refitting, etc.
- While fitment of lever brake cam, match dot mark of Lever brake cam with brake cam dot mark as shown in fig (E).

Note : For CBS setting bring the vehicle to BAL authorised workshop only.

Non-use maintenance is necessary if a vehicle remains off road for a longer duration (more than 15 days**). The correct and careful non-use maintenance carried out before storing the vehicle will prevent the vehicle from rusting and from such other non-operational damages like fire hazards.

- Clean the entire vehicle thoroughly.
- Empty the fuel from the fuel tank and carburettor float bowl (if fuel is left in for a longer time, the fuel will break and gummy substance could clog the carburettor).
- Remove spark plug & put several drops of engine oil into the cylinder. Kick engine over slowly a few times to coat cylinder wall with oil & install back spark plug.
- Set the vehicle on a box or a stand so that both wheels are raised off the ground.
- Spray oil on all unpainted metal surfaces to prevent rusting. Avoid getting oil on rubber parts or brake liners.
- Cover entire vehicle neatly. Make sure that storage area is well ventilated & free from any source of flames or spark.
- Fill 10% excess air pressure in both

wheels.

- Do not apply oil on front brake disc, to prevent rusting. If the front brake disc rusts during storage, do not attempt to clean it with soap water. The rust will go off automatically during first few application of brake.

** For Battery :

- a. Remove battery and keep it on wooden plank, in properly ventilated area.
- b. Before taking the vehicle for use.
 - Get the battery recharged from the Authorised Service Center / Battery Dealer.
 - Apply petroleum jelly on battery terminals.

Preparation for regular use after storage :

- Follow daily safety checks.

Bajaj Auto Limited provides the following warranty in respect of the “**Pulsar 125 BS VI**” motorcycle manufactured by us.

Every possible care and precaution has been taken to ensure quality in respect of the material & workmanship in the vehicles manufactured by us. Bajaj Auto Limited will repair or replace at their Authorised Workshops, free of charge, part or parts thereof as may be found, on examination, to have manufacturing defect within a period of **5 Years or 75,000 Kms.**, whichever is earlier from the date of sale subject to fulfillment of conditions stipulated in part A, B & C given here under

Note : Warranty is applicable for only first owner of vehicle.

Part A:

Warranty claims in respect of such items like shock absorbers, speedometers etc. though claimed through us, are subject to acceptance of the respective manufacturers. In all such cases the decision of the respective manufacturer will be final and binding.

Proprietary parts like tyres, tubes and battery are warranted by their respective manufacturers and should be claimed on them directly by the customer. Bajaj Auto Limited shall not be Liable to replace them

though their dealer, however Bajaj Dealers will provide full assistance in referring such claims with respective manufacturer.

Bajaj Auto Limited undertake no liability in the matter of consequential loss or damage caused due to the failure of the parts. Delay, if any, at the repairing workshop in carrying out repair to vehicle shall not be a ground for extending the warranty period, nor shall it give any right to the customer for claiming any compensation for damages.

Bajaj Auto Limited reserves the right either to repair or replace the defective parts.

Where a defective part can be replaced by part/s of alternative brand/s, which are normally used by Bajaj Auto Limited in the course of manufacture, Bajaj Auto Limited reserves the right to carry out the replacement by a part or parts of any such alternative brand/s.

This warranty and any claim arising there, is subject to Pune jurisdiction only.

Part B:

No claim for exchange or repair can be considered unless the customer :

- a. Ensures that immediately upon detection of the defect, he approaches any nearest Authorised Bajaj Vehicle Dealers & Recommended Authorised Service Dealers with the concerned vehicle and enables him

to remove and despatch the part / parts attributing to the manufacturing defect to the Company.

- b. Produces the Owner's Manual, in original, to enable that dealer to verify the details.

It must be expressly understood that claims forwarded directly to us by the owner / customer will not be entertained at all and such defective part/parts thus forwarded by them will lie at our factory at their own risk, and this warranty shall not be enforceable.

To avail benefits of warranty, following are mandatory

1. Availing of Initial 3 Free Services without lapse.
2. Availing paid services at subsequent 5000 kms. or 120 days from last service whichever is earlier without any lapse.
3. Availing of all services at the Authorised Vehicle Dealers & Recommended Authorised Service Dealers.
4. Usage of only recommended engine oil "**Bajaj DTS-i 10000**" at specified frequency for drain interval of 10,000 kms. & engine oil level top-up at 5000 kms.
5. Replacing mandatory periodic parts such as air filter, oil filter etc. as per periodic maintenance schedule.

Part C :

Further this warranty is NOT applicable to :

1. Normal maintenance operations like brake & clutch adjustments, cleaning of fuel system, engine tune-up or such other adjustments.
2. Parts subjected to normal wear & tear like Clutch Plates, Brake Shoes, Chain, Sprockets, Fork Oil Seal, Spark Plug, Control Cables, Brake Pads.
3. Replacement of bulbs & rubber components like grommets, 'O' rings, bellows as well as filters, packings, gaskets, fasteners etc.
4. Painted parts. Only blistering or peeling off of paint film are covered under warranty. Any defect arising out due to external damages or due to usage of protective covers /additional protective coatings adverse atmospheric conditions etc. are not allowed like under warranty.
5. All consumables like Engine oil, Fork oil, Brake Oil, Grease etc. are chargeable to customer.
6. Any defect arising due to above consumables not changed as per scheduled or if used other than the recommended one.
7. Never drive your bike through flooded roads or a flooded patch, as damages to the engine parts due to water entry is not covered under warranty.

8. All chrome plated parts are prone to rust or corrosion in coastal area or in acidic environment or due to neglected cleaning etc. However chrome film peeling is covered under warranty in general atmospheric conditions. Blue/ Yellow colouration of silencer near exhaust port is permissible and hence not covered under warranty.
9. Oxidation of unpainted/painted crankcase, cylinder block, cylinder head etc. in acidic environment or in a coastal area.
10. Parts of the vehicle that have been subjected to misuse, accident, negligent treatment OR which have been used in conjunction with parts & an equipment not manufactured or recommended for use by Bajaj Auto Limited, if found is the sole judgement of Bajaj Auto Limited, such use prematurely affects the performance and reliability of the vehicle.
11. Parts of the vehicle that have been altered and modified or replaced in unauthorized manner like use of wider tyres, loud silencers etc and which in the sole judgement of the Bajaj Auto Limited affects its performance and reliability.
12. **Vehicles which are not being serviced at recommended dealers as per the service schedule described or which have not been operated or maintained in accordance with the instructions maintained in the Owner's Manual.**
13. Vehicles used for any competition or race and/or for attempting to set up any kind of record.
14. Any failure arising due to use of adulterated or bad quality fuel.
Parts affected due to bad fuel quality are not covered Under warranty.
15. If additional electrical accessories such as - Remote, Bigger horn, Musical brake light etc. fitted on vehicle.
16. If the vehicle has been used for commercial purpose like Taxi or any other means of commercial transportation.

Bajaj Auto Limited reserves the right to make any changes in design or to add any improvements on the vehicle at any time without incurring any obligation to install the same on a vehicle previously supplied and sold. Also, the conditions of this warranty are subject to alteration without any notice.

This warranty is the entire written warranty given by Bajaj Auto Limited for “**Pulsar 125 BS VI**” motorcycle’ and no other dealer or its or his agent or employee is authorised to extend or enlarge this warranty.

BATTERY WARRANTY CARD

MAKE OF BATTERY :

MFG. CODE OF BATTERY :

SR.NO.:

TYPE OF BATTERY :

DATE OF SALE :

NAME OF OWNER AND ADDRESS :

TYPE OF VEHICLE :

REG. NO.:

FRAME NO.:

ENGINE NO.:

SERVICE RECORD

Sr. No.	Date	Age Mths.	Specific Gravity	Voltage	Remarks	Dealer's Stamp & Signature	* Code
1							
2							
3							
4							
5							
6							

* Code For Remarks:

LL : Low electrolyte level.

AE : Electrical system needs attention.

IR : Insufficient running of vehicle.

CB : Cover broken.

BC : Broken Container.

PM : Poor maintenance.

BA : Battery abused.

Note : Customer should insist that "Service Record" must be filled by respective authorised battery dealer as proof of specified maintenance for easy settlement of claim, if any.

TO BE FILLED IN BY BATTERY DEALERS / DISTRIBUTORS IN CASE OF CLAIM

Name of Dealer & Code : _____

Date of claim : _____ Battery Type : _____

Serial No. : _____ Date of Fitment : _____

Failure Mode (Please tick as applicable)

- Loose connection
- Internal Short
- Plate Shedding
- Intercell Connection
- Does not Hold Charge
- Wrong Assembly
- Wrong Application
- Terminal Corroded
- Overcharge / Undercharge
- Reverse Charge
- High Specific Gravity Electrolyte
- Electrolyte Contamination
- Electrolyte Level not Maintained
- Left Lying Idle

Claim Accepted

Claim Rejected

Details of Repair, if any _____

Note:

Please contact nearest respective authorised battery dealer for details immediately after purchase of vehicle.

Use only Bajaj Genuine Oil

pulsar
125

BAJAJ
DTS-i
10,000
10W 30

BAJAJ
DTS-i
10,000
10W 30

Top up bottle 100 ml.

Always Use Bajaj Genuine High Performance Engine Oils

World's Favourite Indian

4⁺ Star Performance

Long Drain Interval of 10,000 kms*

Reduced Friction

Clean Engine Parts, Longer Engine Life

Smooth Clutch Control

*** Top up recommended at 5,000 kms**

We are committed to provide the best of sales & service experience, however should you require any additional assistance, please call our Call centre on the number given below.



: 7219821111

Call charges are as applicable

**Call centre timings :- Monday to Sunday
(09 : 00 am - 08 : 00 pm)**



Please download customer care app from '**Google play store**' and '**Apple store**' and book the vehicles for servicing and more on your phone.

E-mail : customerservice@bajajauto.co.in

Web Site : www.bajajauto.com

CIN : L65993PN2007PLC130076